3V-40V V_{in} , 300mA, 2.4 μ A I_Q , Low-Dropout Regulator with PG Feature

±

±

SCT71403Q Series

Part Number	Output Voltage	Package	Package Marking	Transport Media, Quantity

SCT71403Q Series

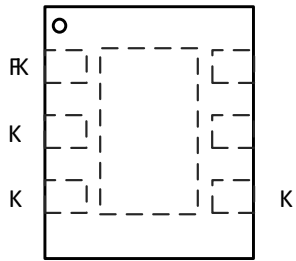

SCT71403FxxAQDVAR

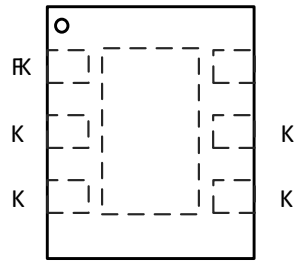

SCT71403FxxQDVAR

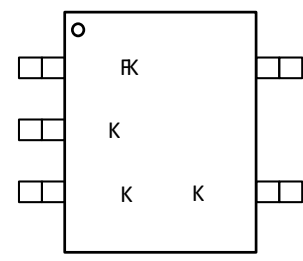

SCT71403FxxQTWDR

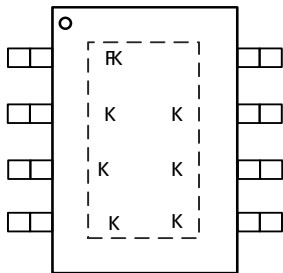

SCT71403FxxQMTER

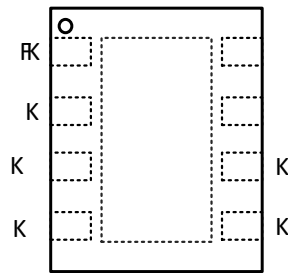

SCT71403FxxQDTBR

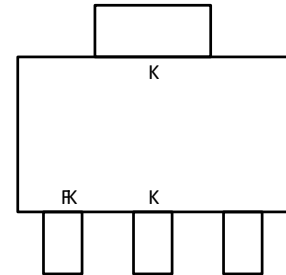

SCT71403FxxQTXER

NAME

SCT71403Q Series

PARAMETER	DEFINITION	MIN	MAX	UNIT

PARAMETER	DEFINITION	MIN	MAX	UNIT

- (1)
- (2)

PARAMETER	DEFINITION	MIN	MAX	UNIT

Package Type	$R_{JA}^{(1)}$	$R_{JC}^{(2)}$	$R_{JA_EVM}^{(3)}$	UNIT

- (1)
- (2)
- (3)

SCT71403Q Series

SCT71403Q Series

SYMBOL	PARAMETER	TEST CONDITION	MIN	TYP	MAX	UNIT
Thermal Protection						

(1)

(2)

SCT71403Q Series

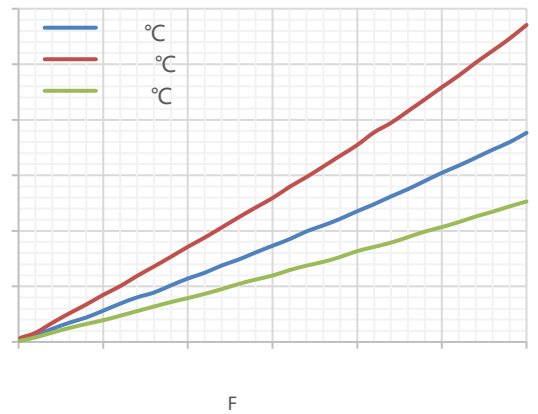
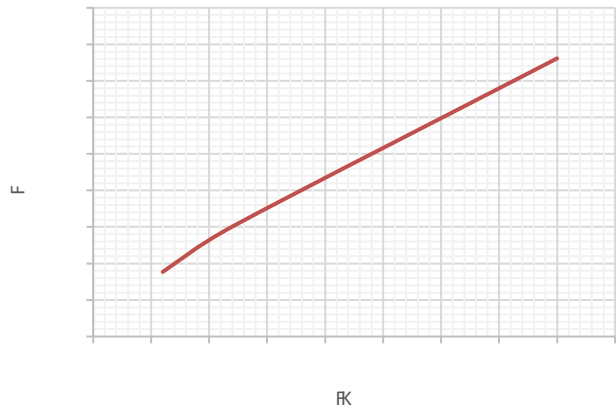
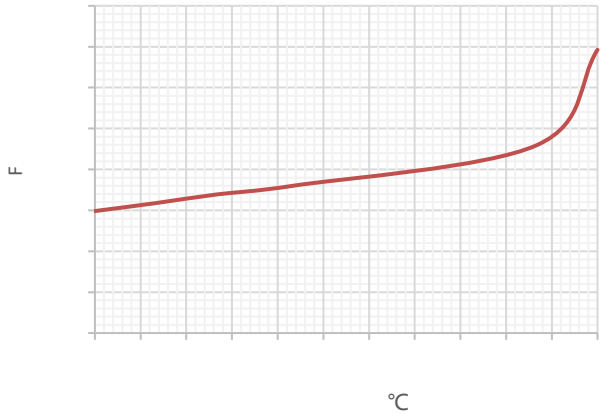
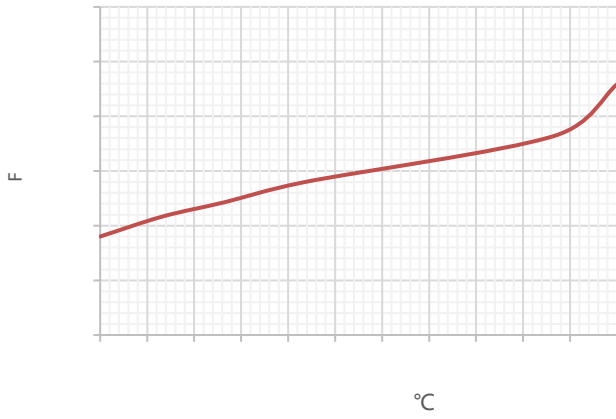
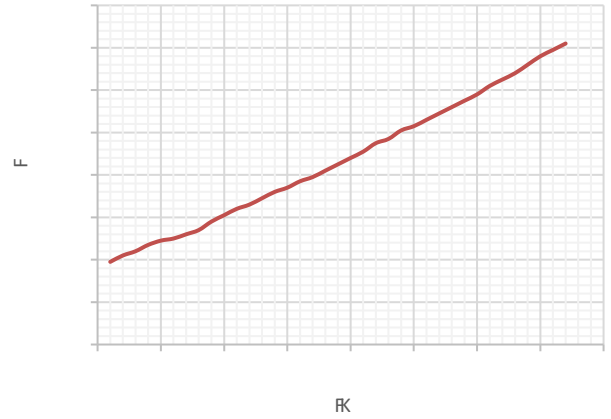
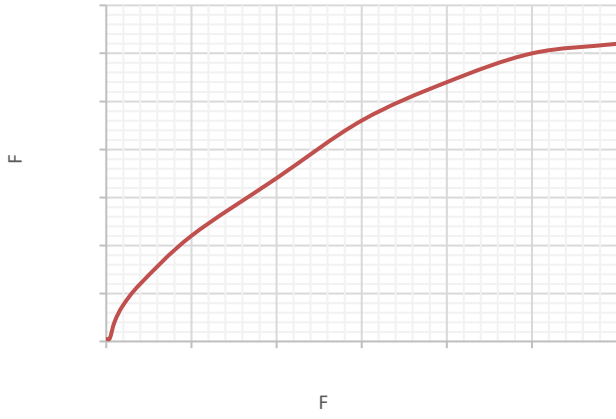



°C



°C

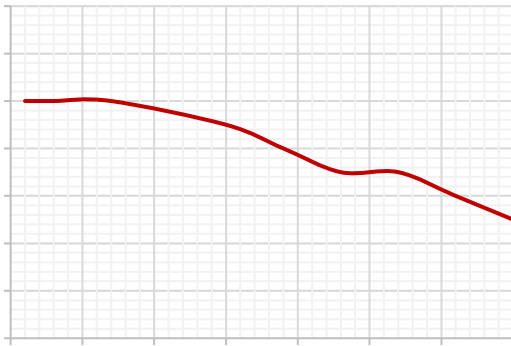

RK

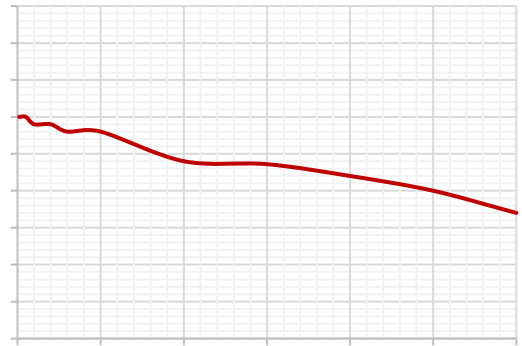

F



°C



F

°C

SCT71403Q Series

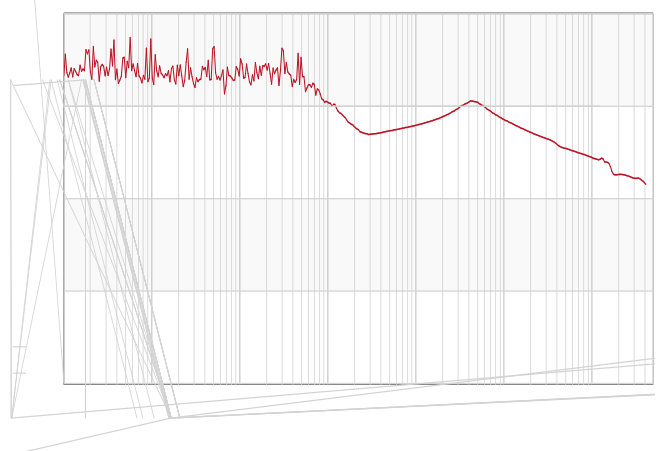
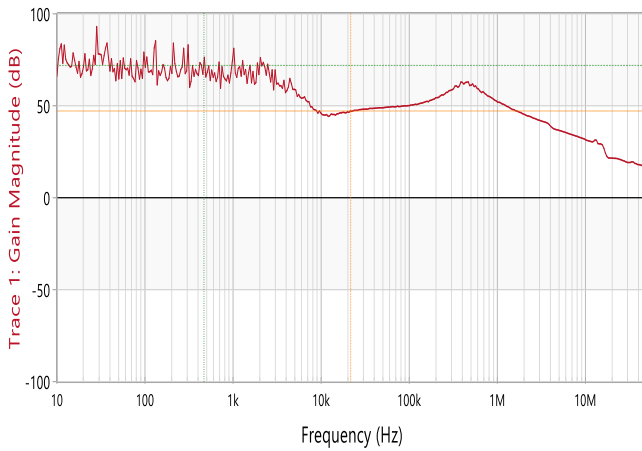
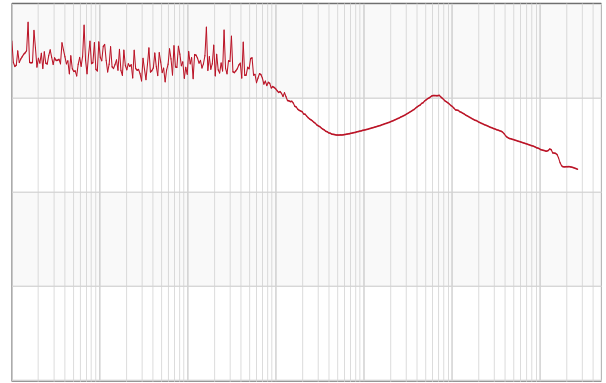
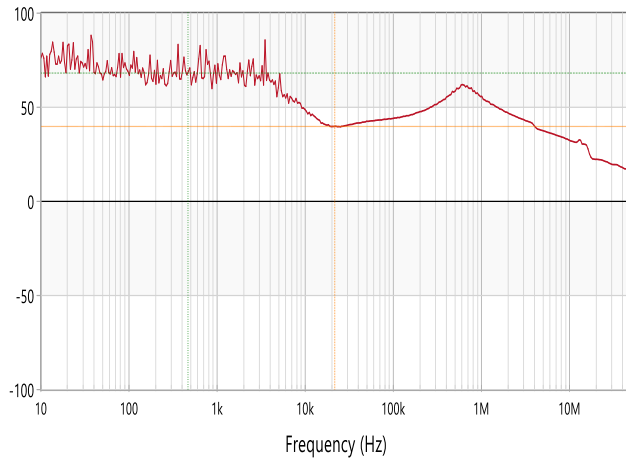
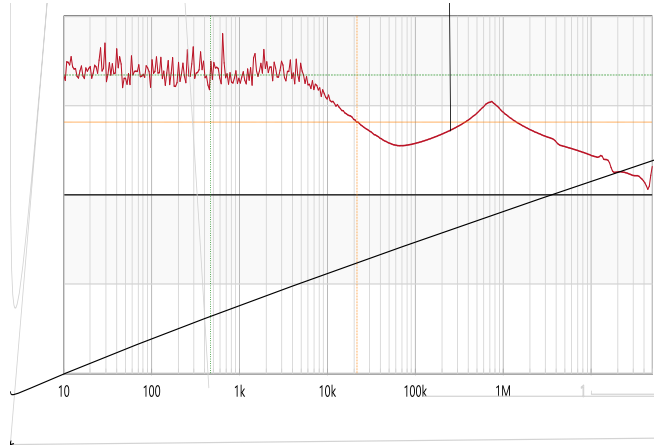
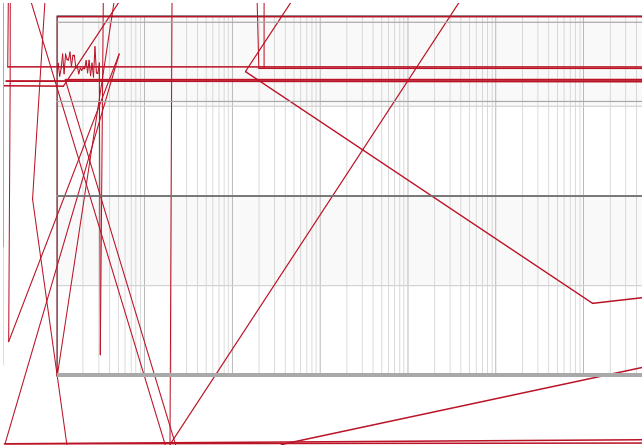

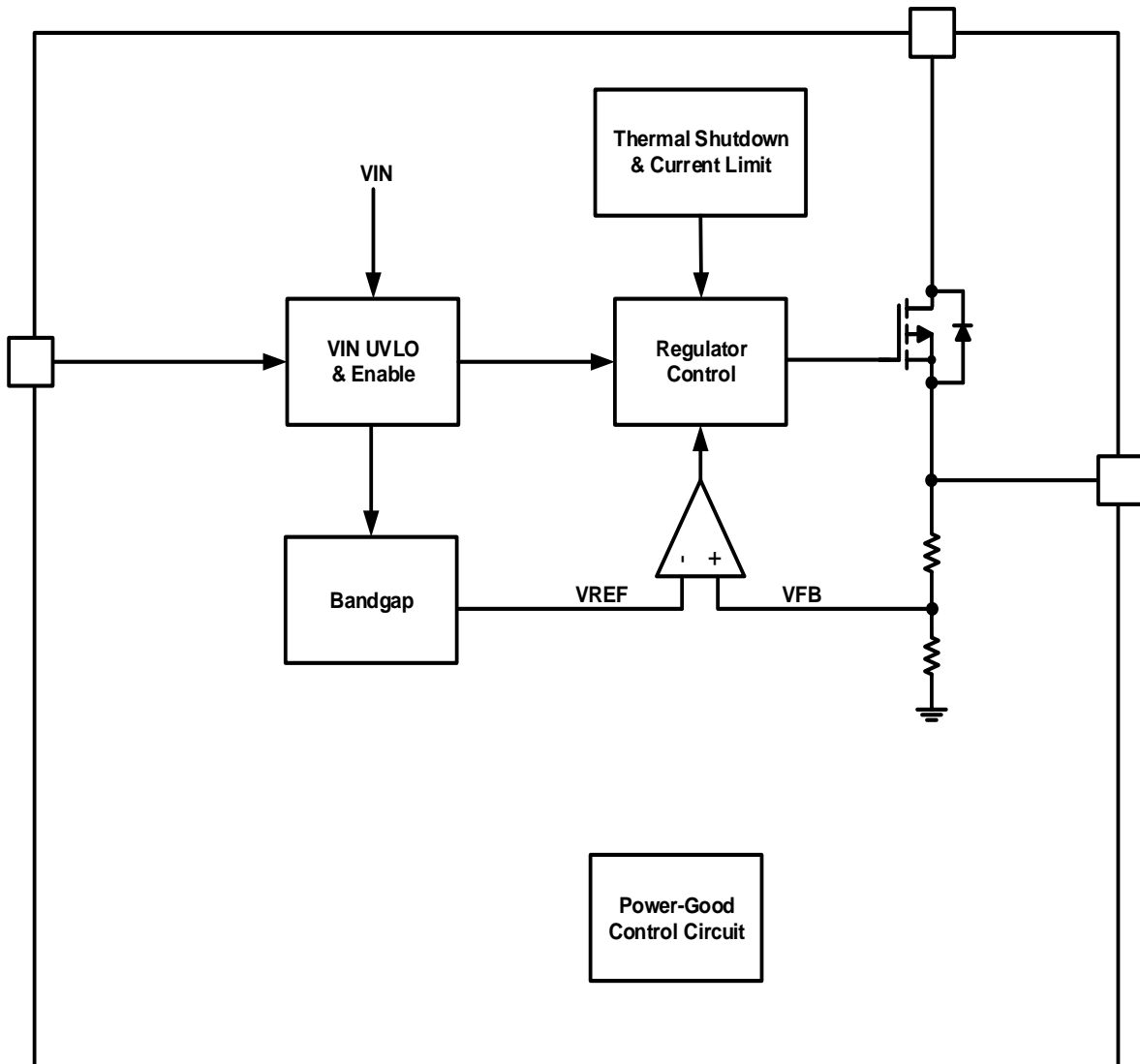

SCT71403Q Series

Overview

Enable and Under Voltage Lockout Threshold

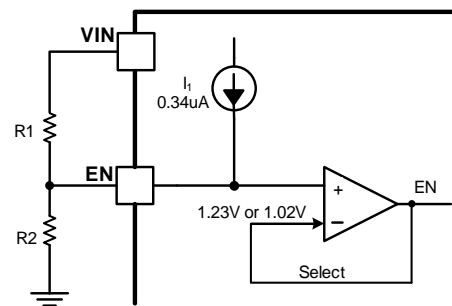

Regulated Output Voltage

SCT71403Q Series

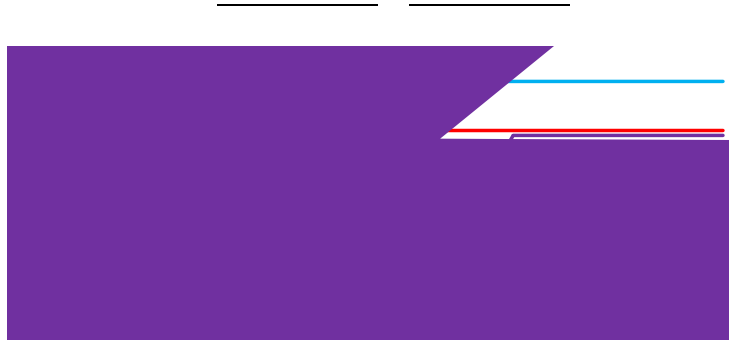

SCT71403Q Series

Typical application 1:

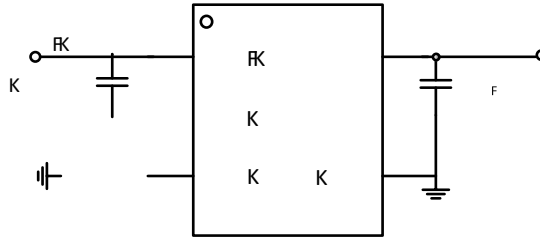

Design Parameters

Design Parameters	Example Value

Typical application 2:

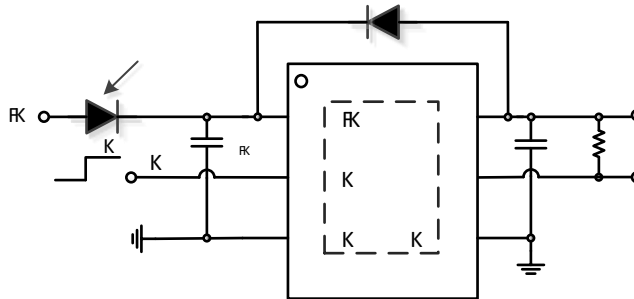

Design Parameters

Design Parameters	Example Value

Power Dissipation and Thermal Performance

SCT71403Q Series

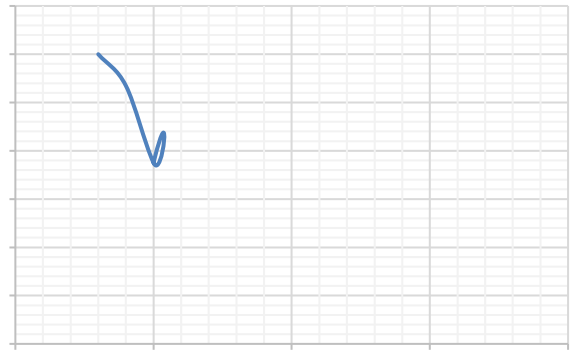
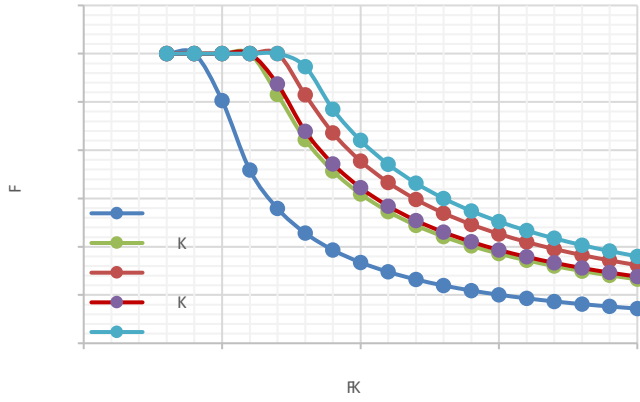

°C

°C

°C

°C

SCT71403Q Series

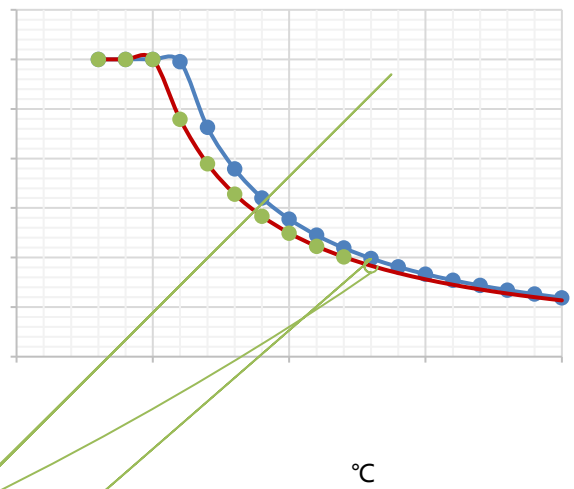
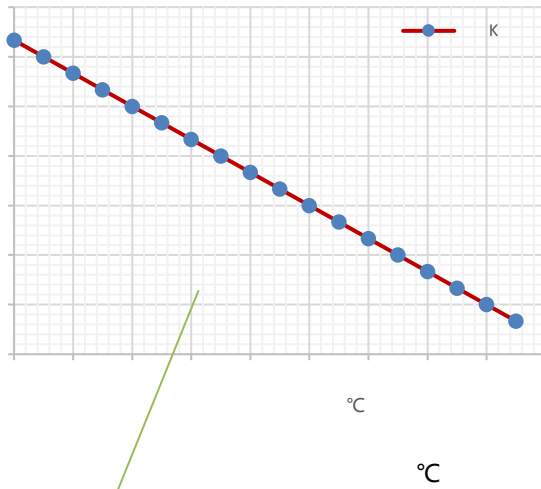
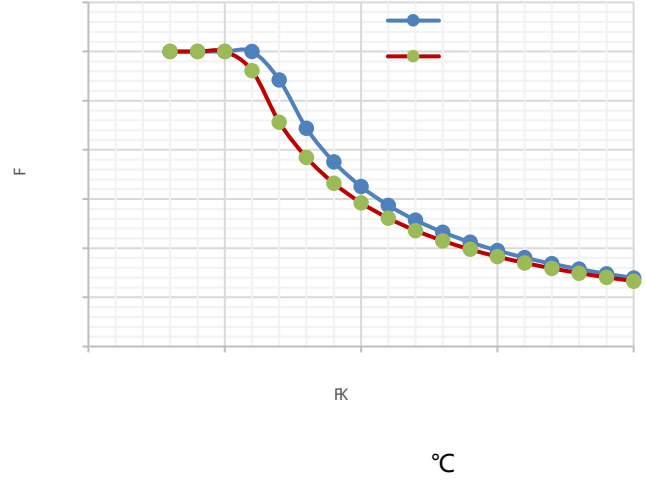
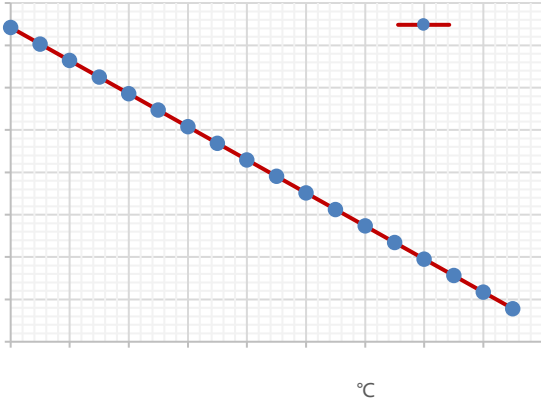

SCT71403Q Series

Application Waveforms

Application Waveforms(Continued)

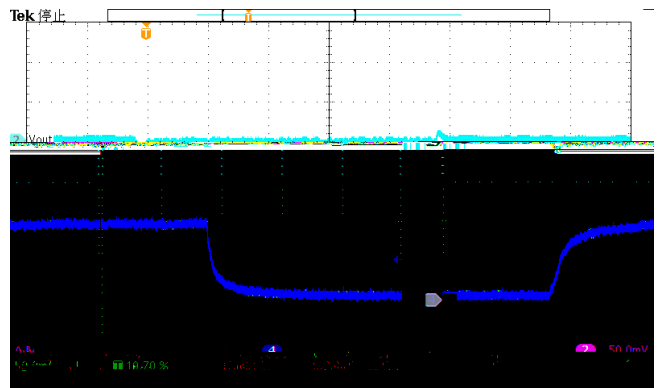
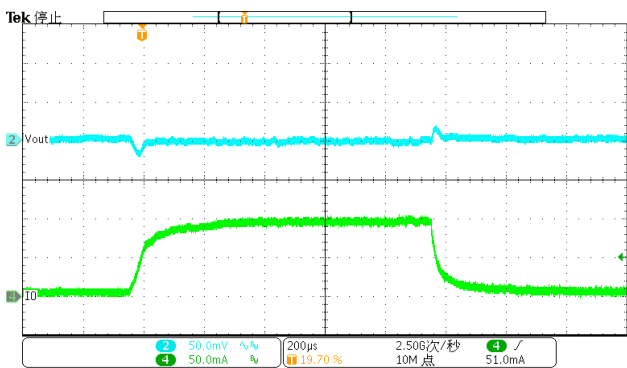
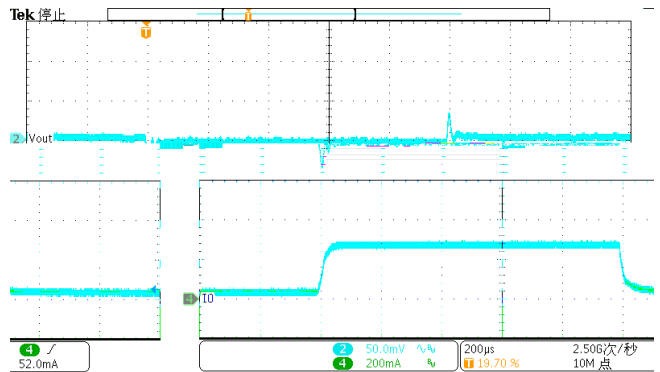
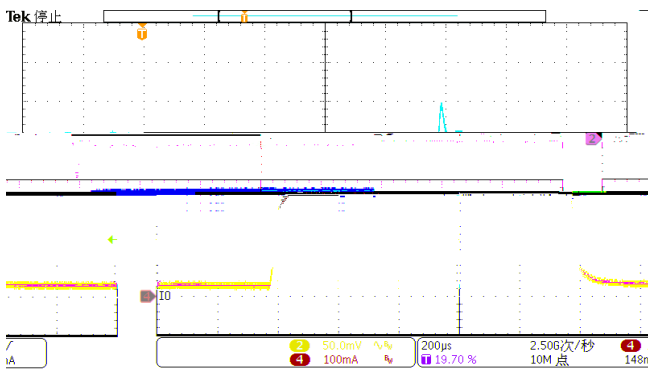
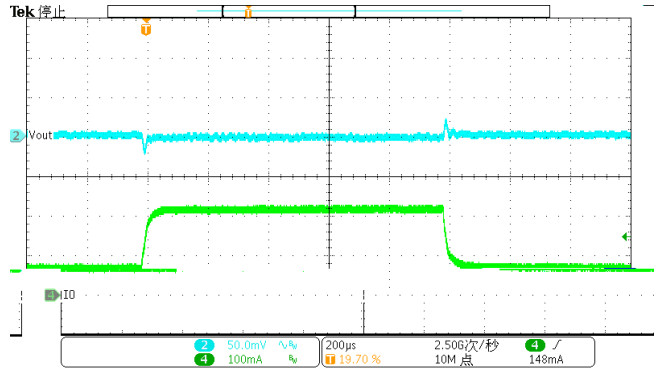
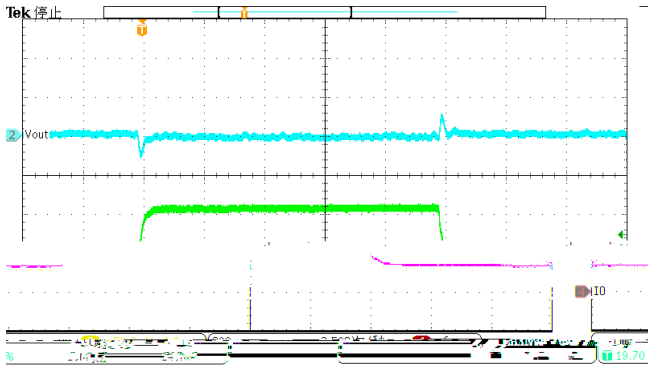

SCT71403Q Series

Application Waveforms(Continued)

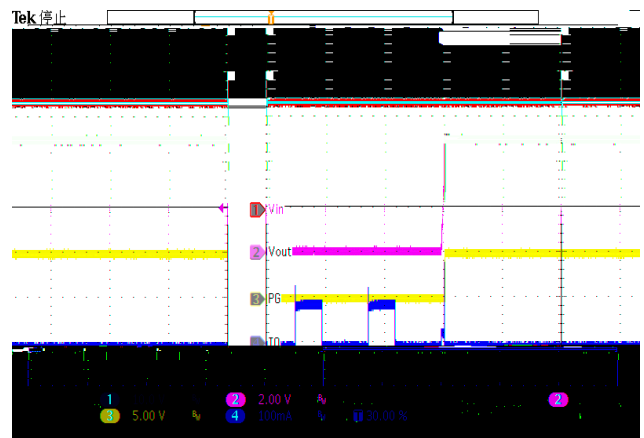
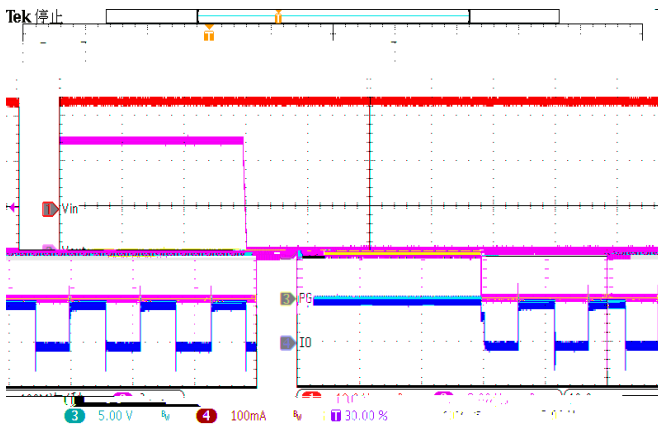
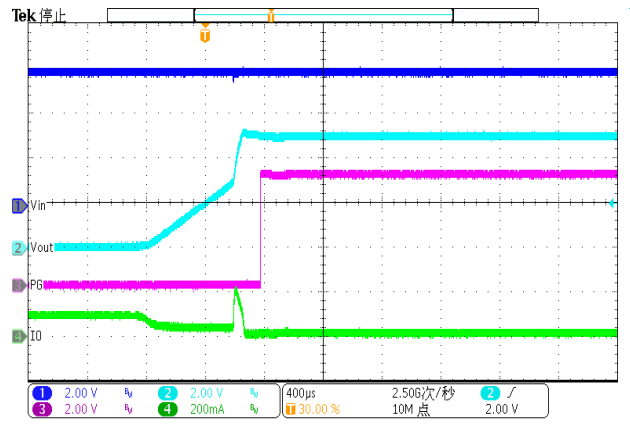
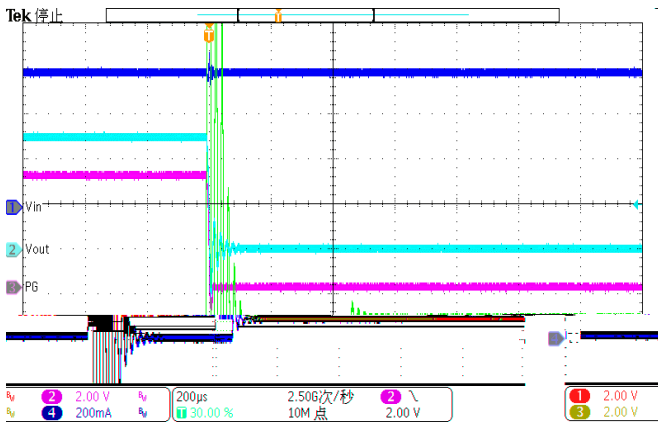
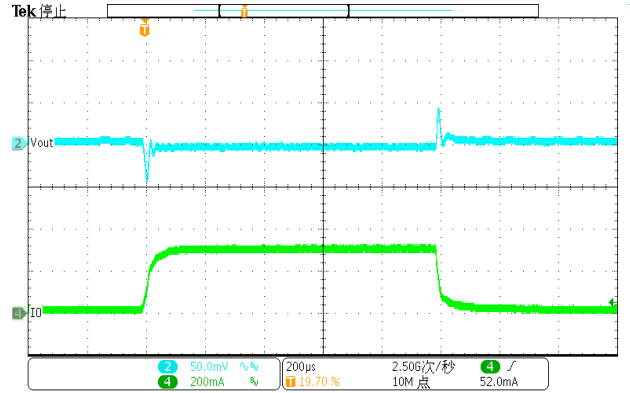
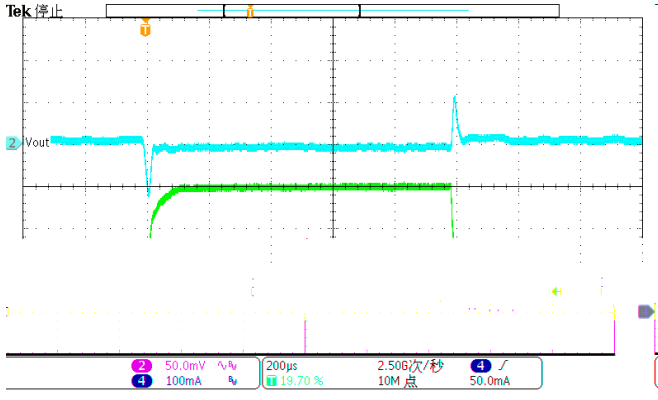

Layout Guideline

- 1.
- 2.
- 3.
- 4.
- 5.

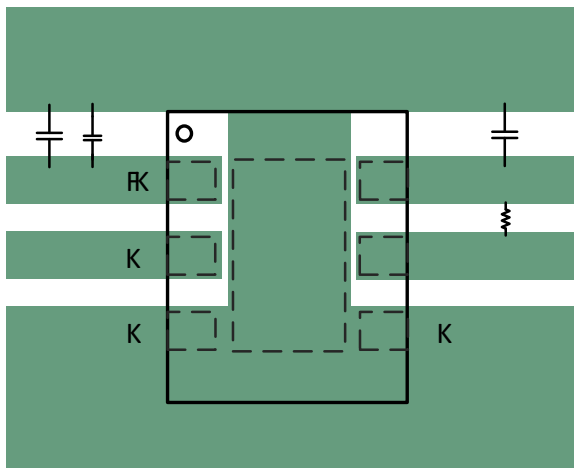

SCT71403FxxAQDVAR

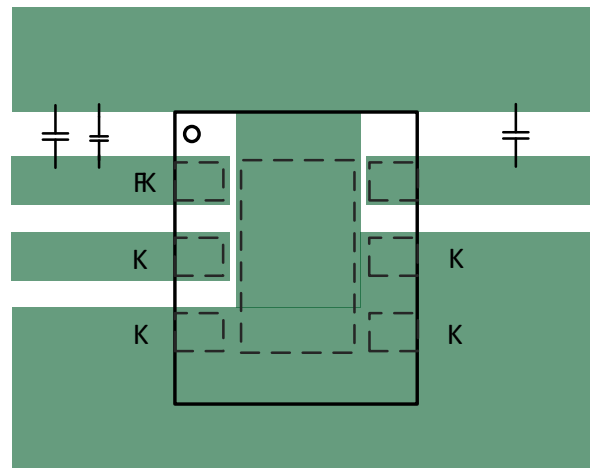

SCT71403FxxQDVAR

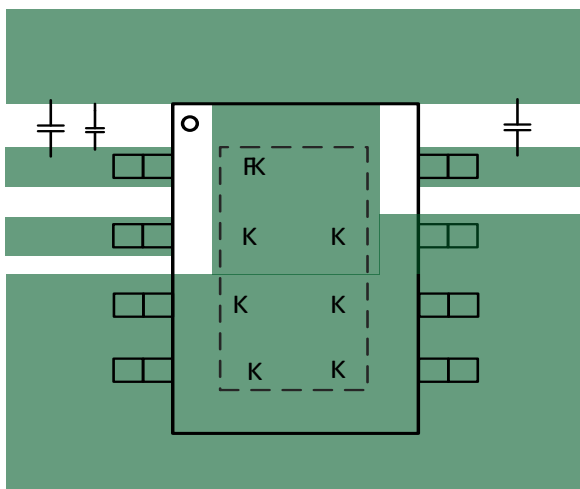

SCT71403FxxQMTER

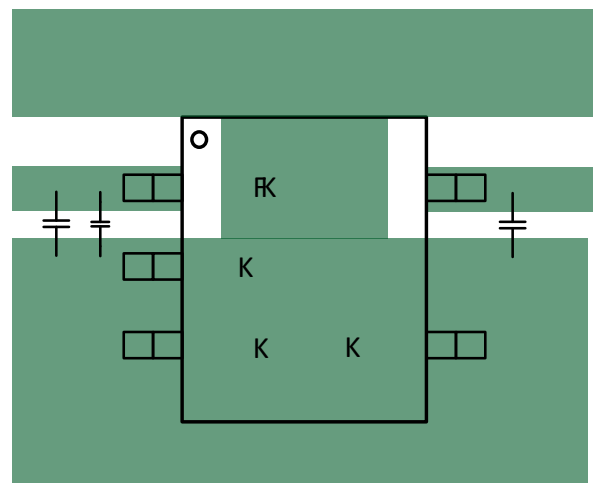

SCT71403FxxQTWDR

SCT71403Q Series

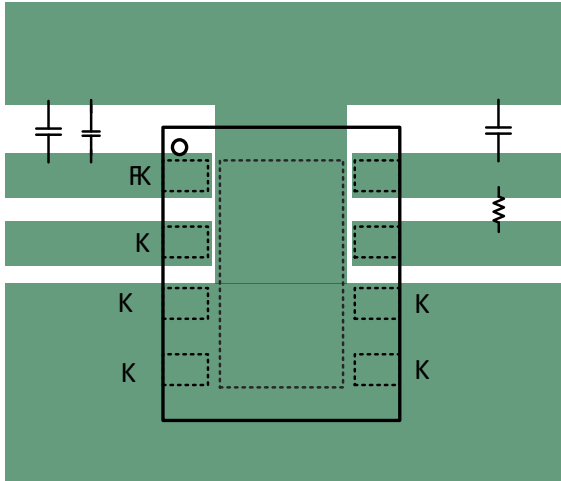

SCT71403FxxQDTBR

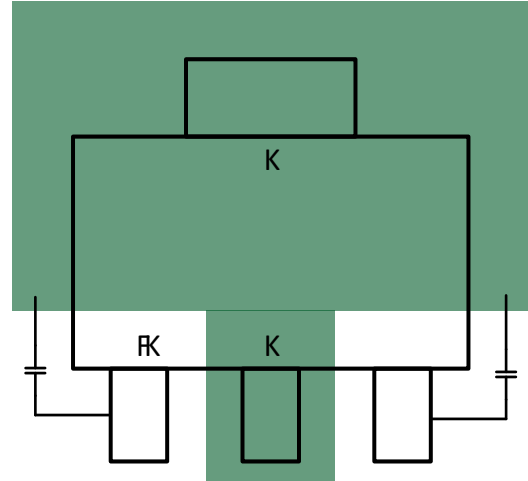

SCT71403FxxQTXER

SCT71403Q Series

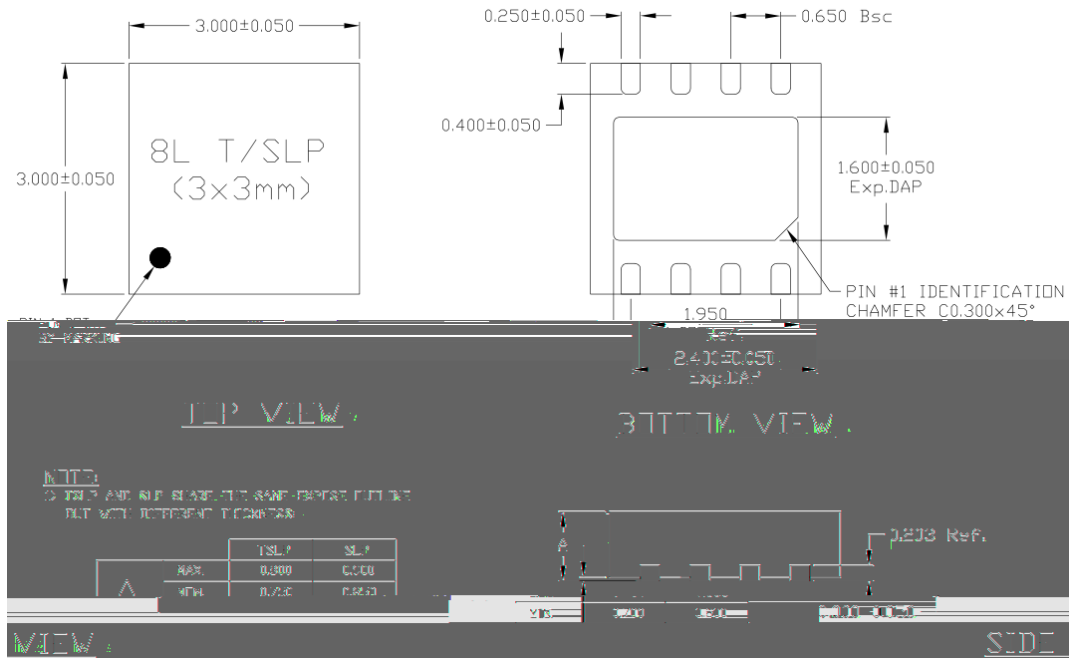

NOTE:

- 1.
- 2.
- 3.
- 4.
- 5.
- 6.

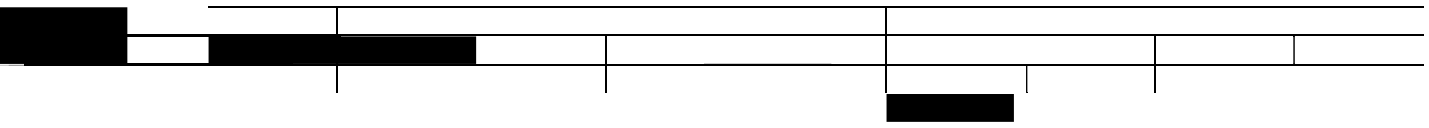

SCT71403Q Series

NOTICE: