

---

## 3V-40V Vin, 300mA, 2.4uA I<sub>Q</sub>, Low-Dropout Regulator with PG Feature

±

±



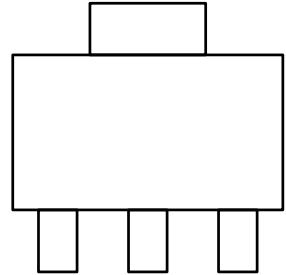
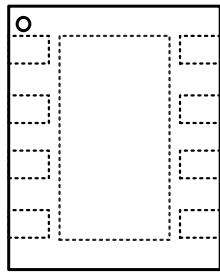
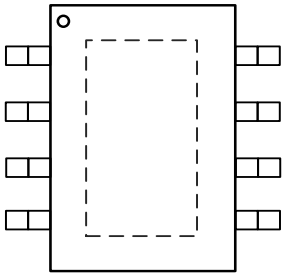
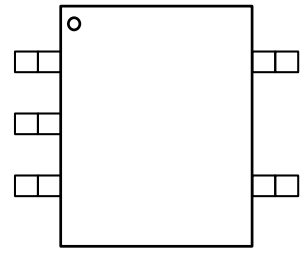
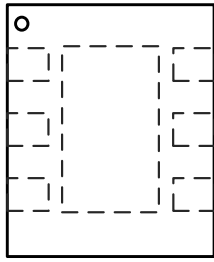
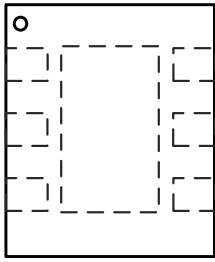

---







(1)

(2)

---



- (1)
- (2)
- (3)

---

---

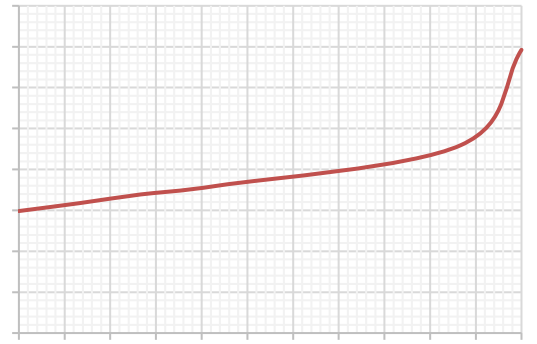
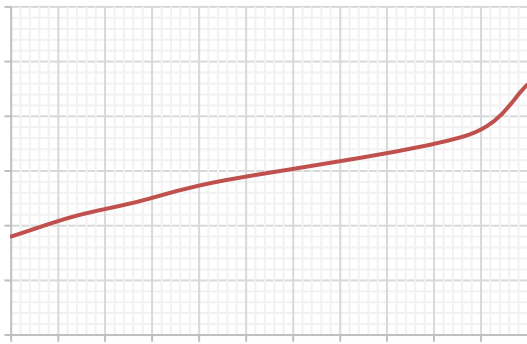
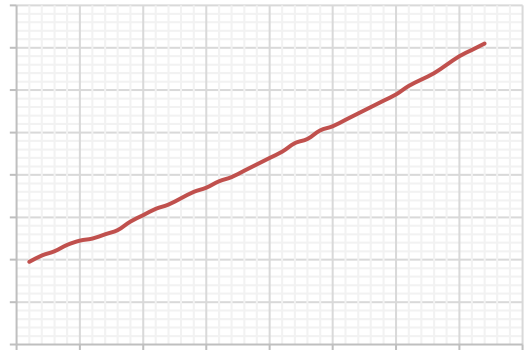
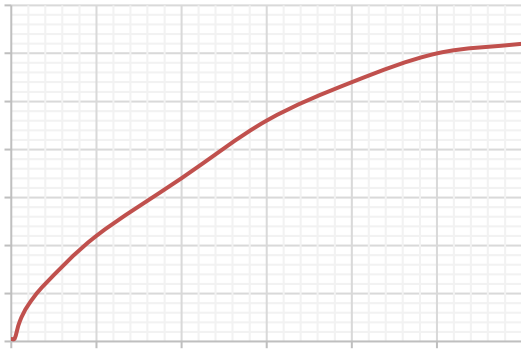

(1)

(2)

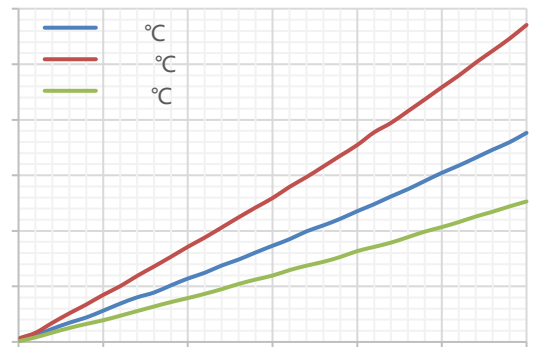

°C

°C







°C



°C

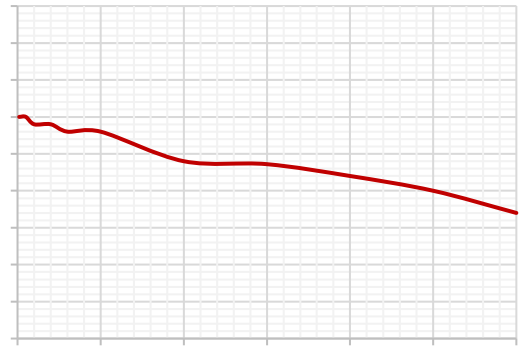
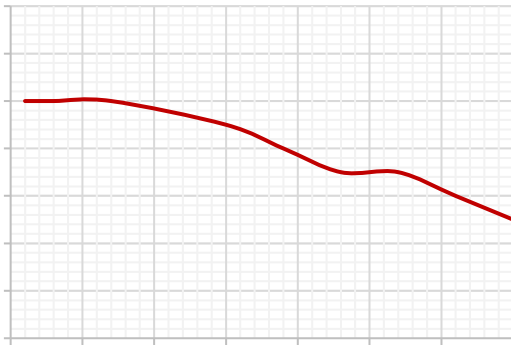

°C



°C

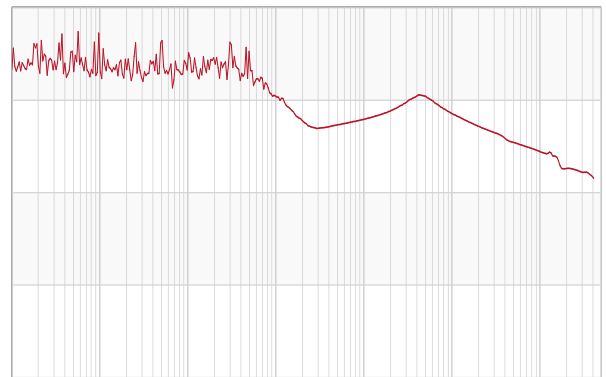
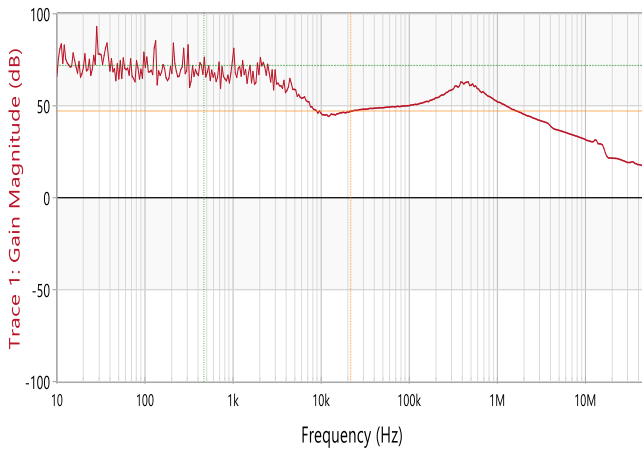
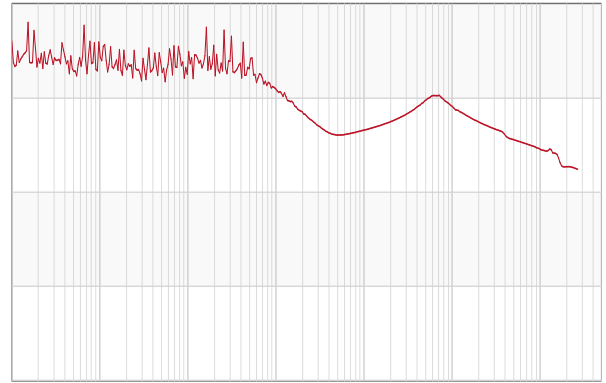
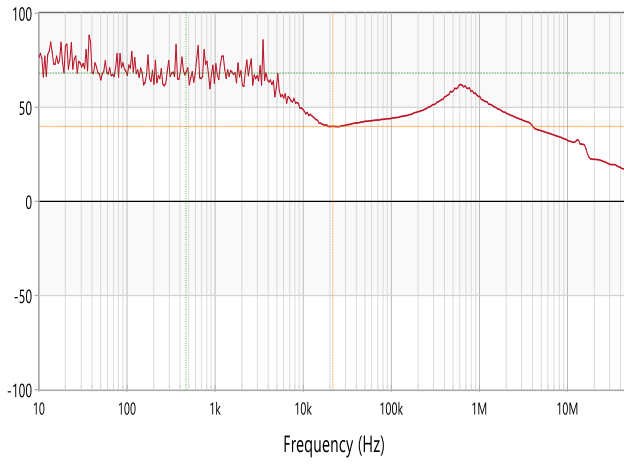
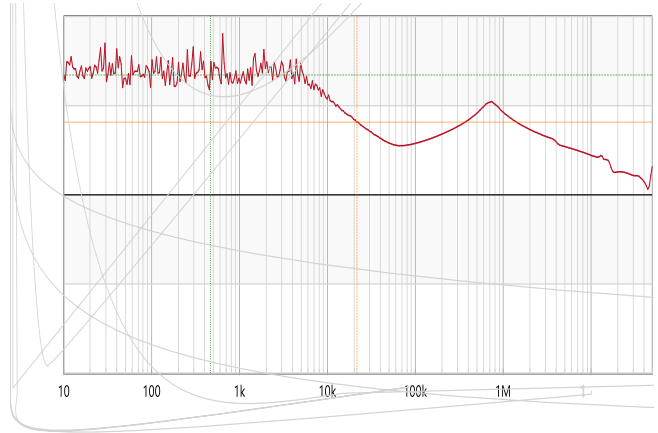
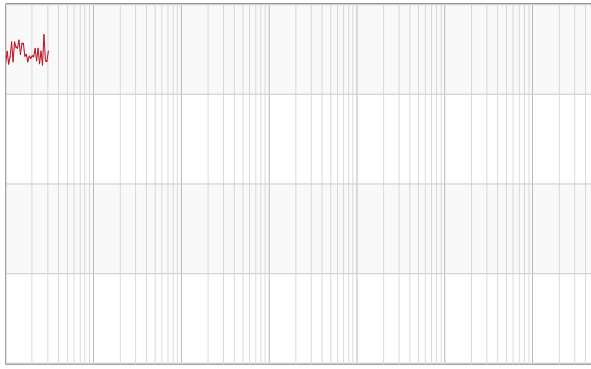

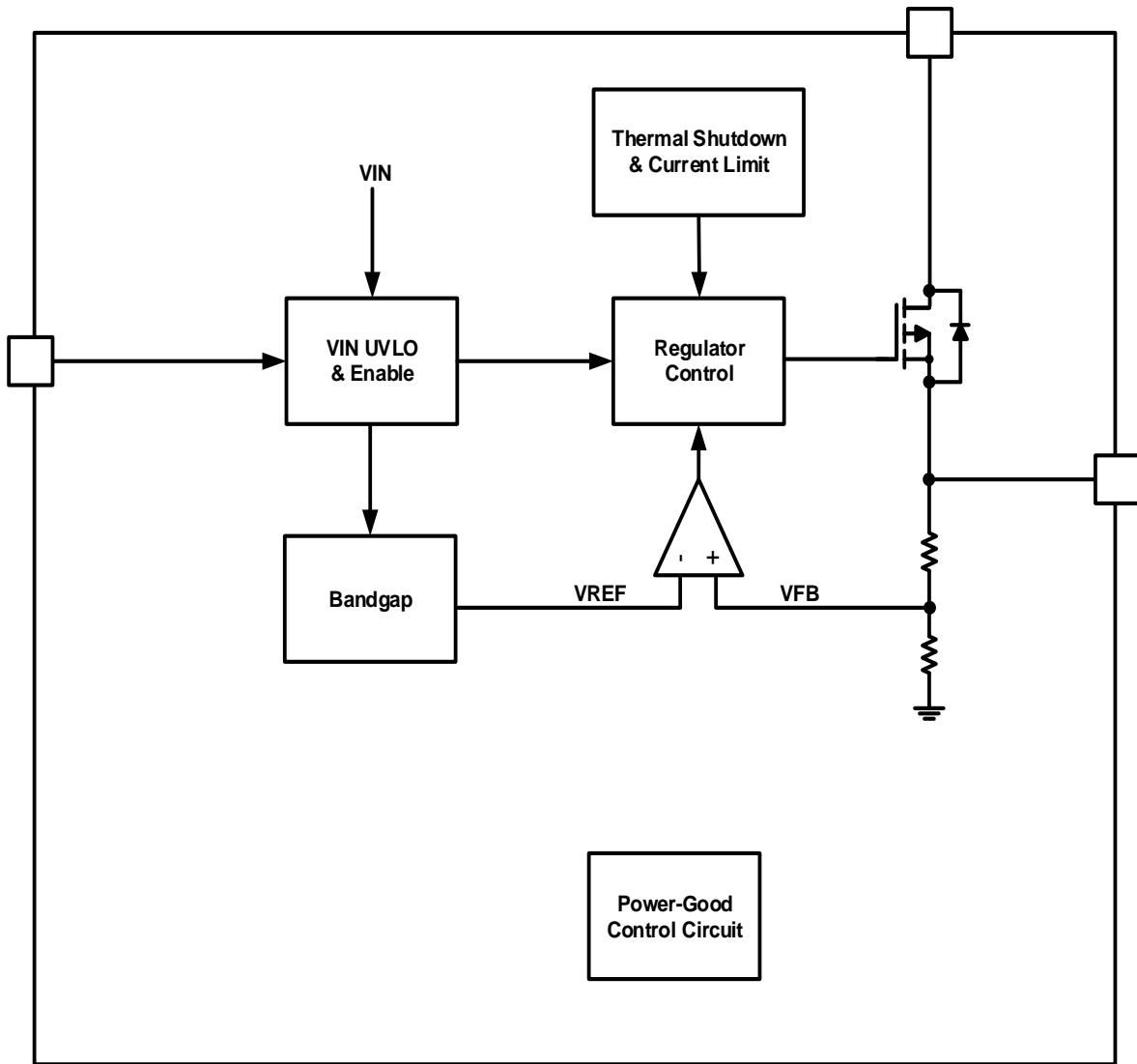

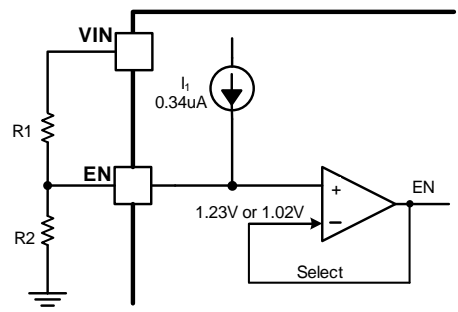
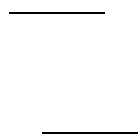

---

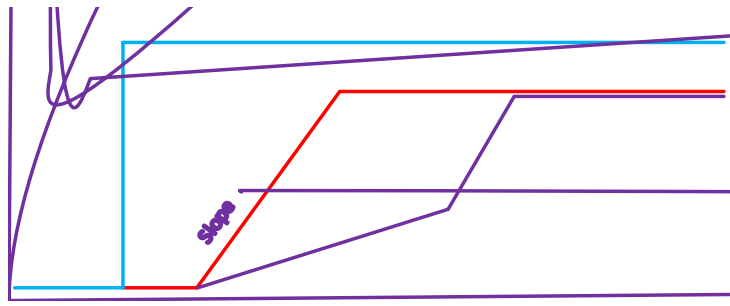



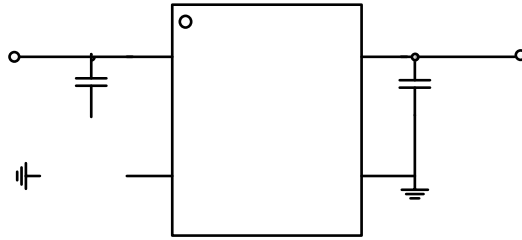

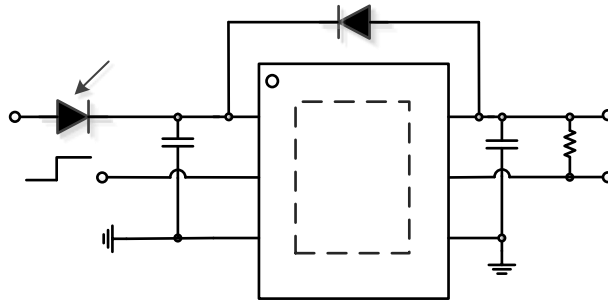



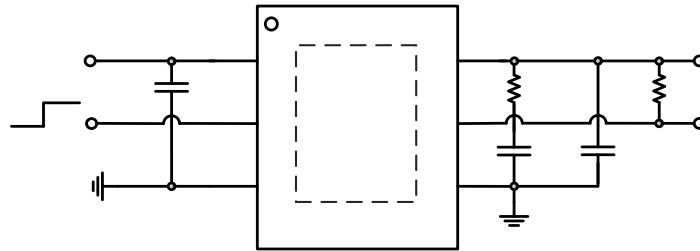



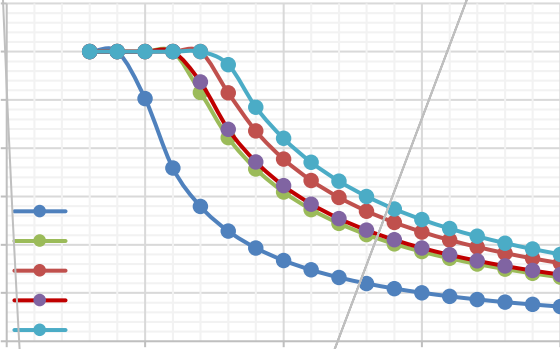

°C

°C

°C

°C





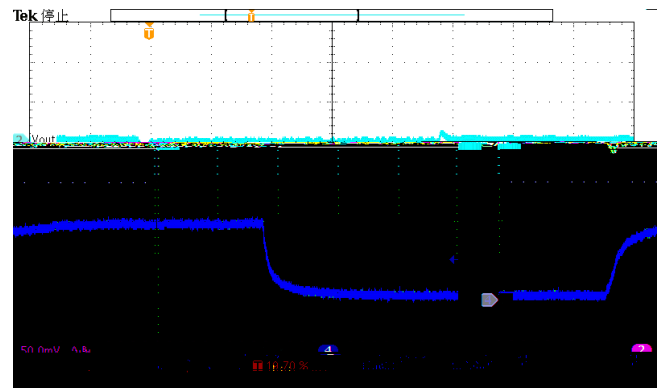
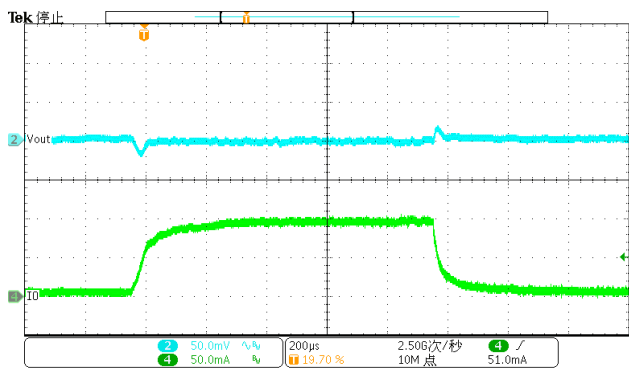
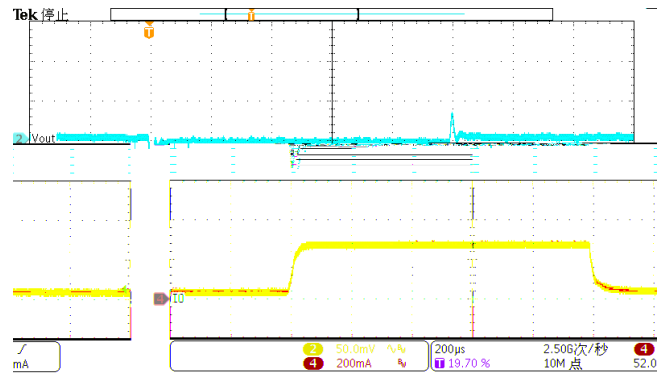
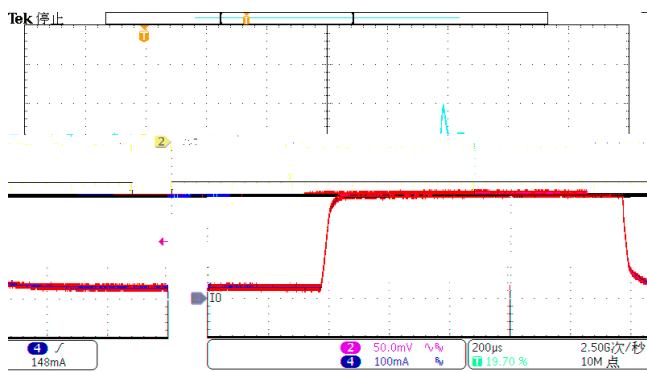
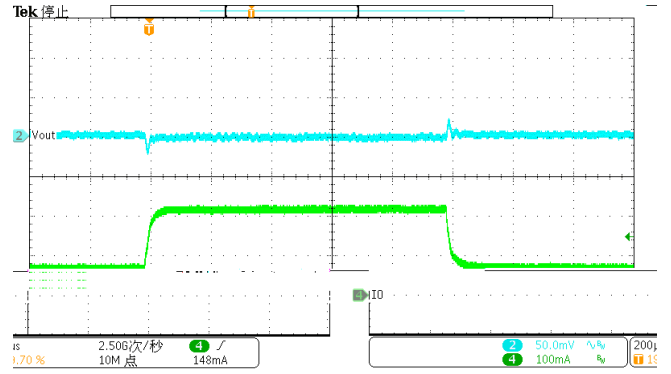
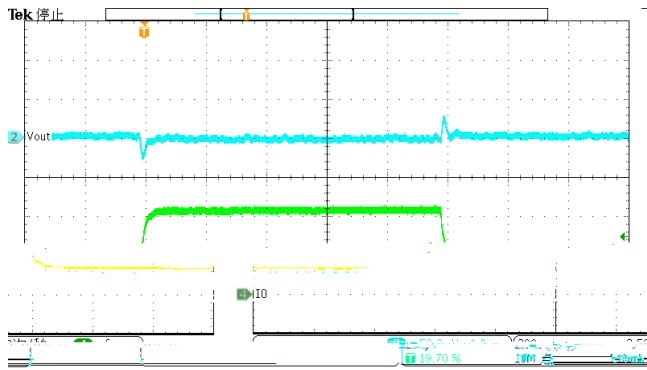

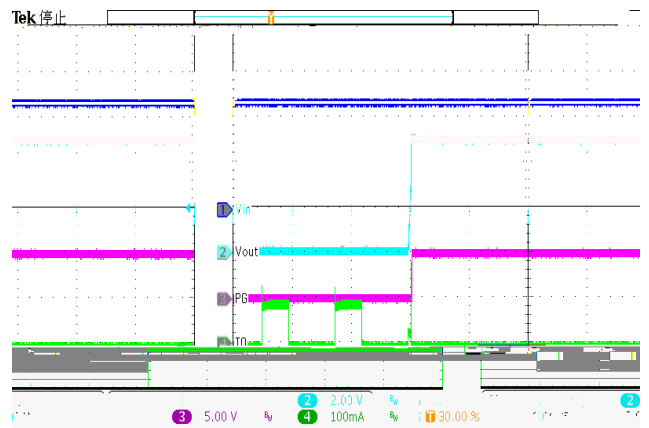
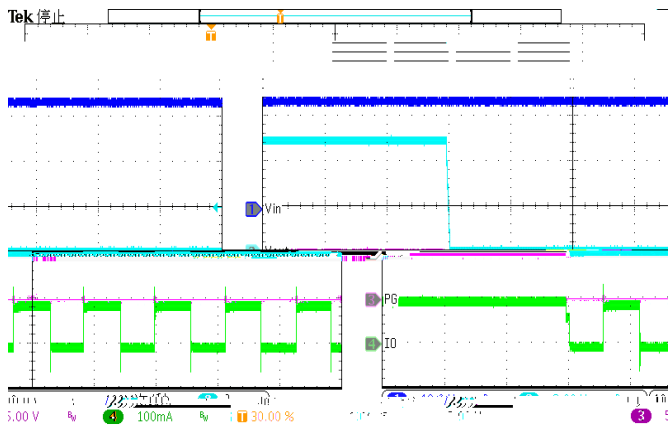
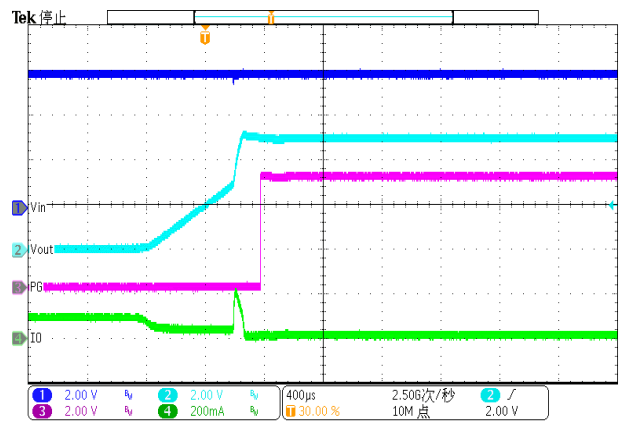
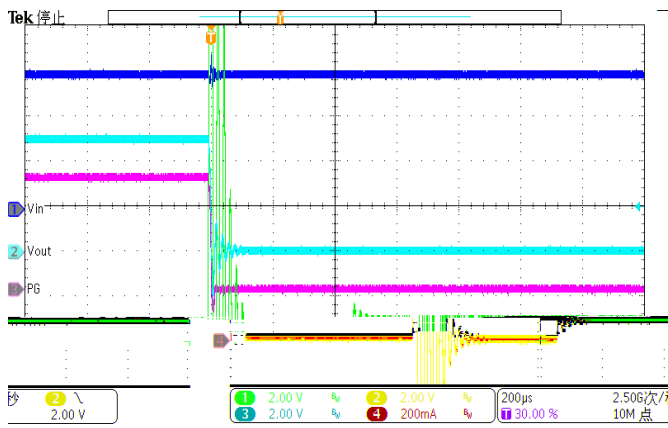
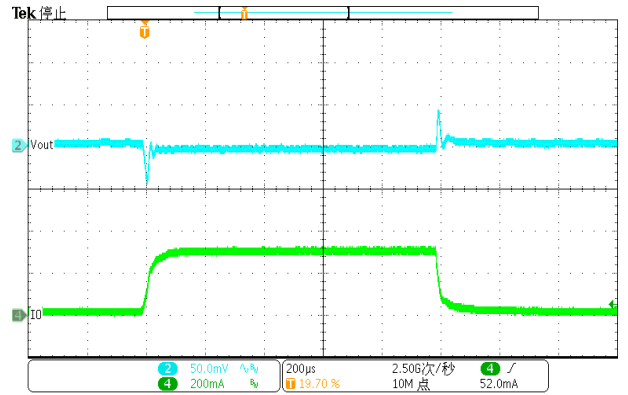
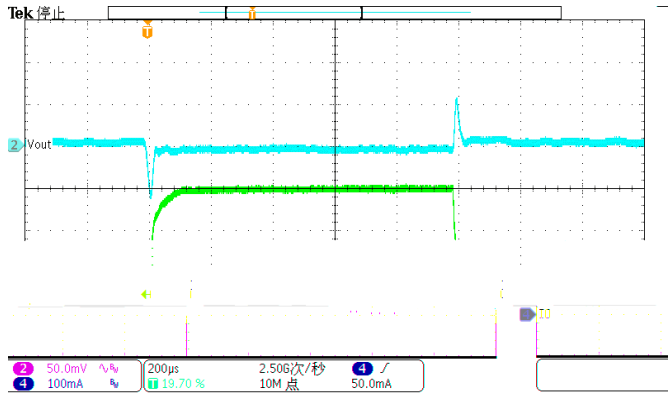



- 
- 1.
  - 2.
  - 3.
  - 4.
  - 5.

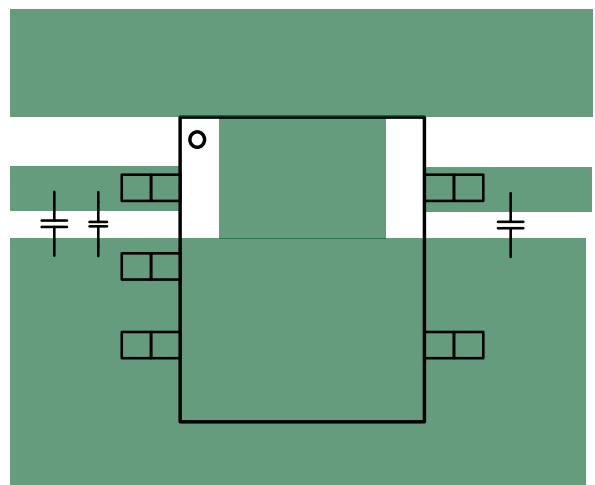
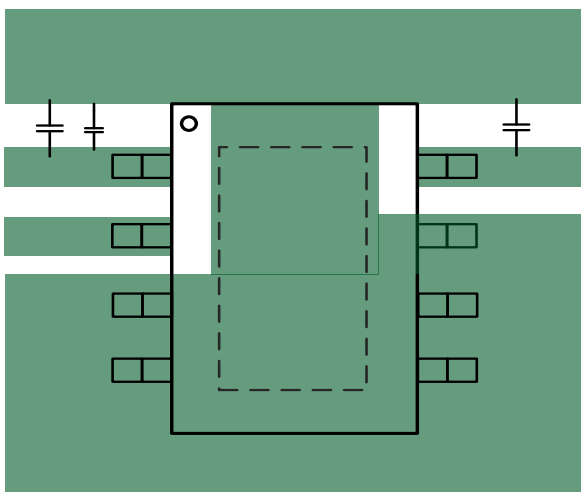
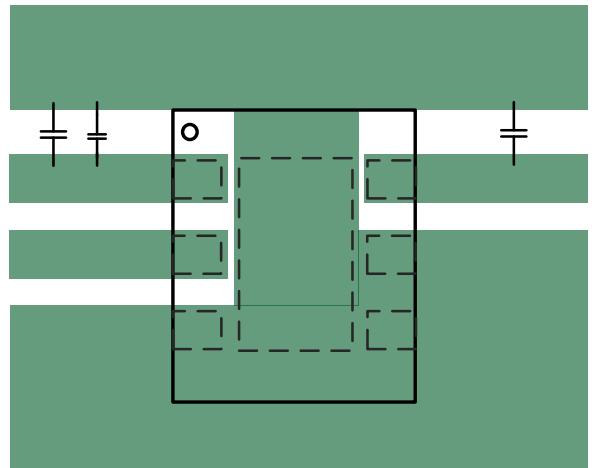
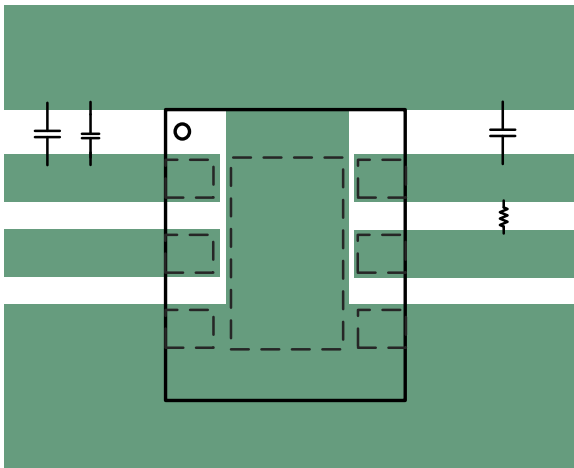

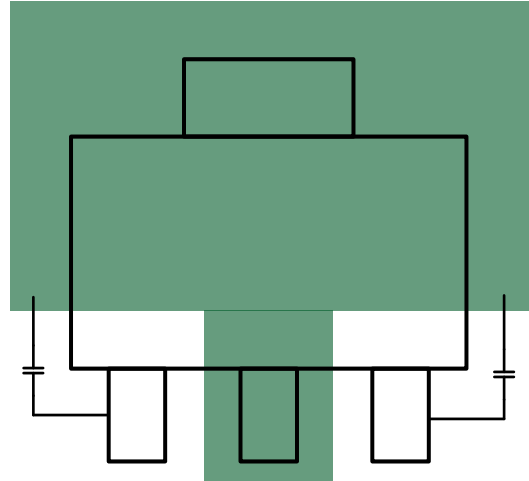
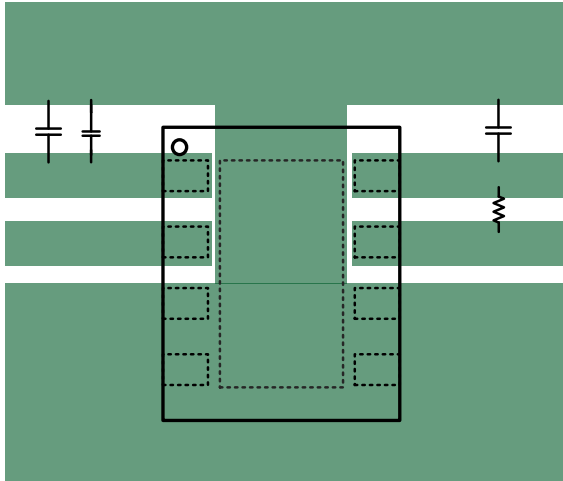

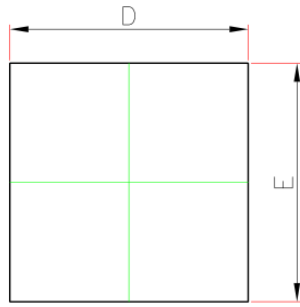

TOP VIEW

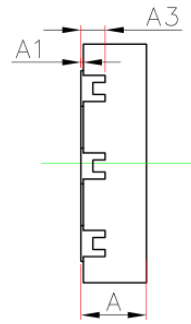

SIDE VIEW

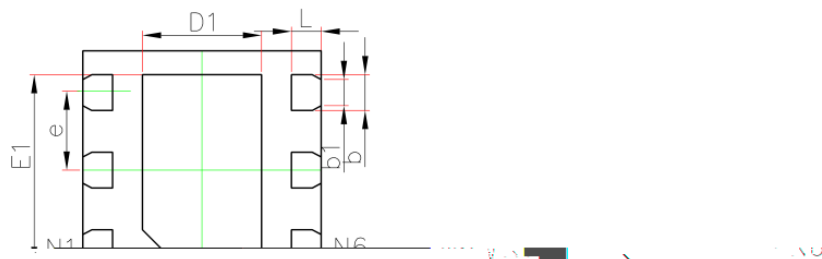

BOTTOM VIEW

- 1.
- 2.
- 3.
- 4.
- 5.
- 6.





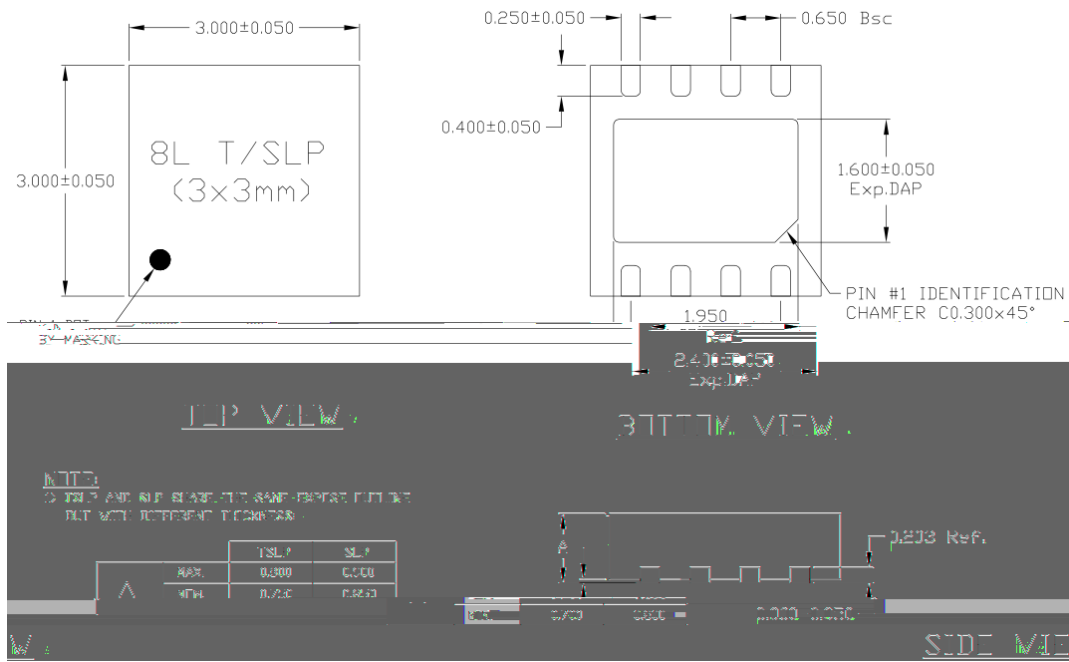

- 1.
- 2.
- 3.
- 4.
- 5.
- 6.



--	--	--	--	--	--



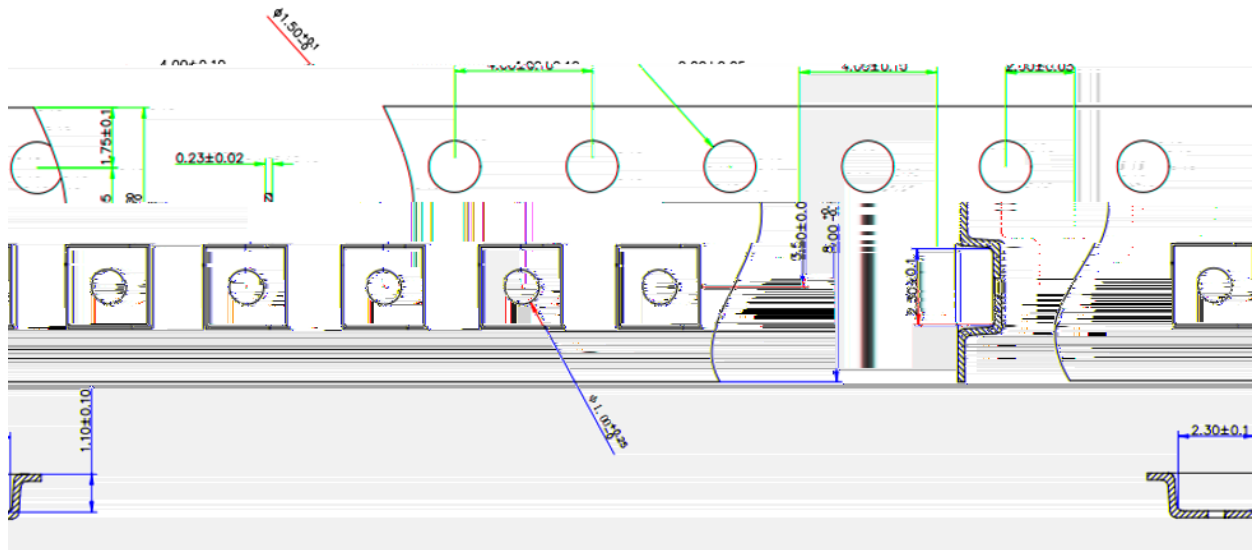
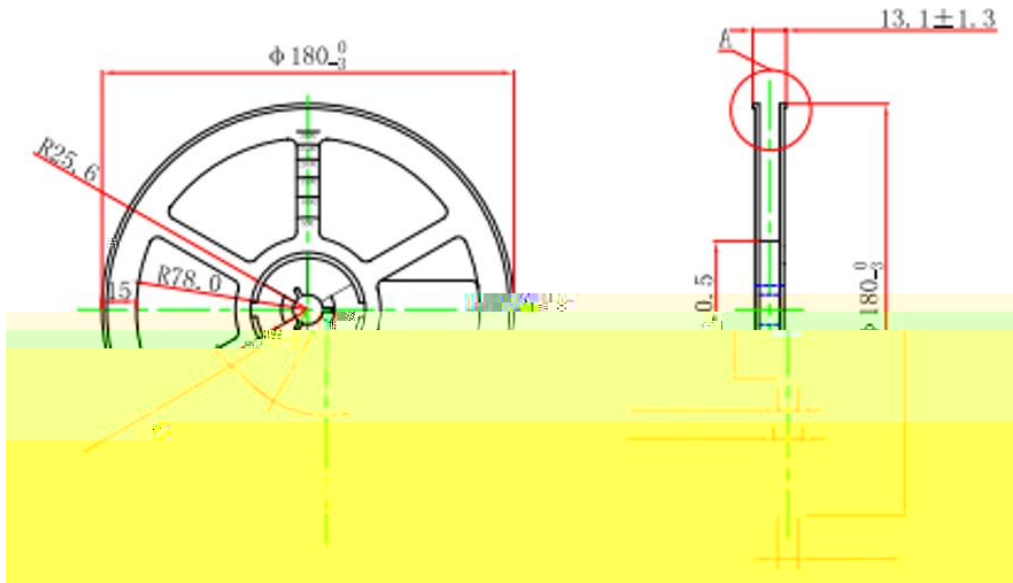



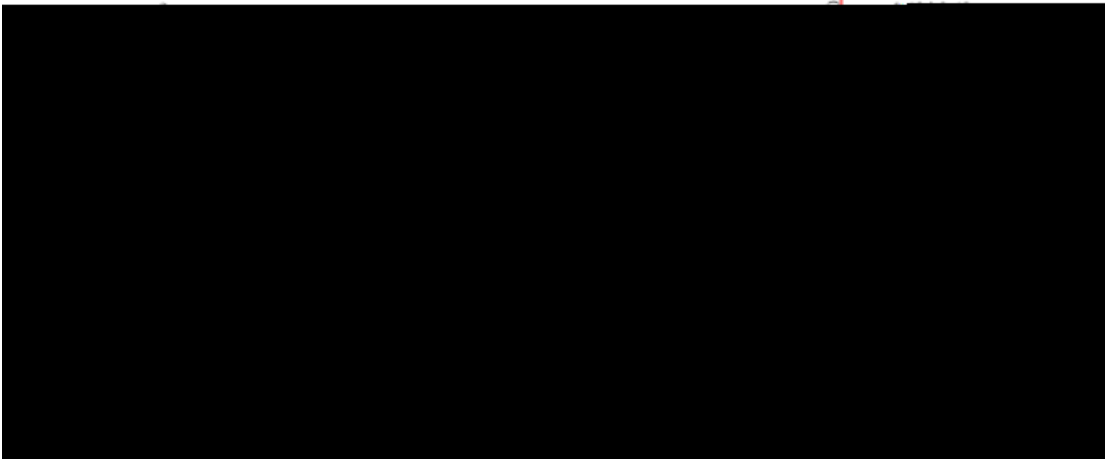
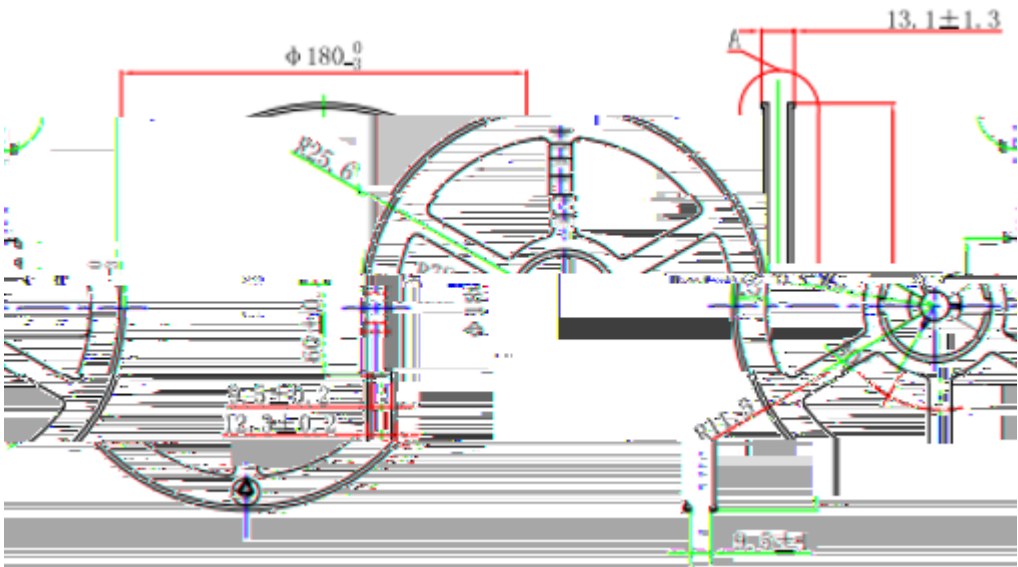

---

---

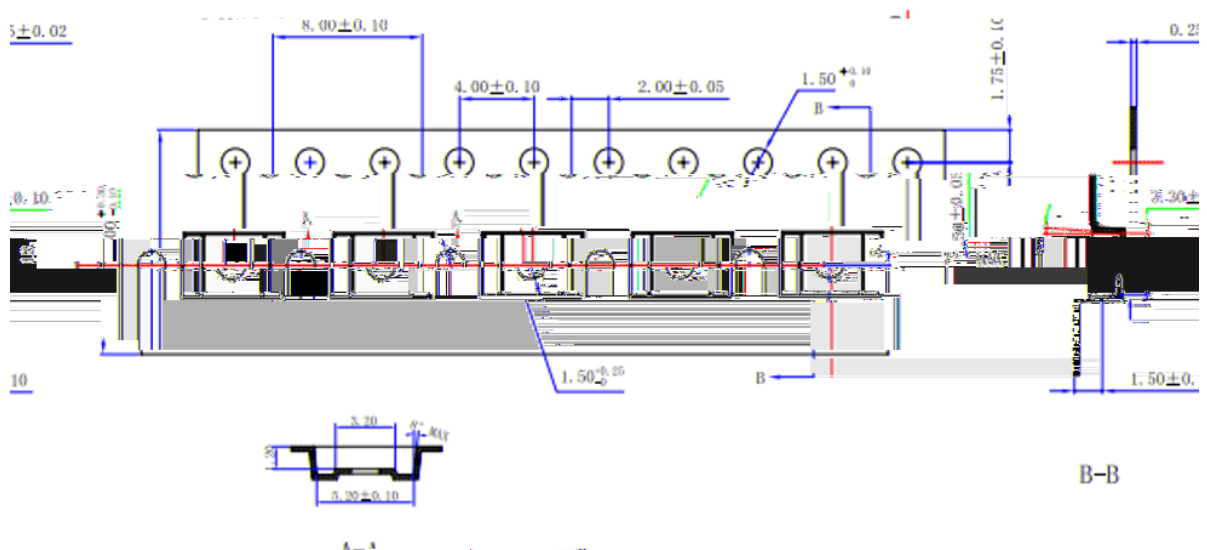
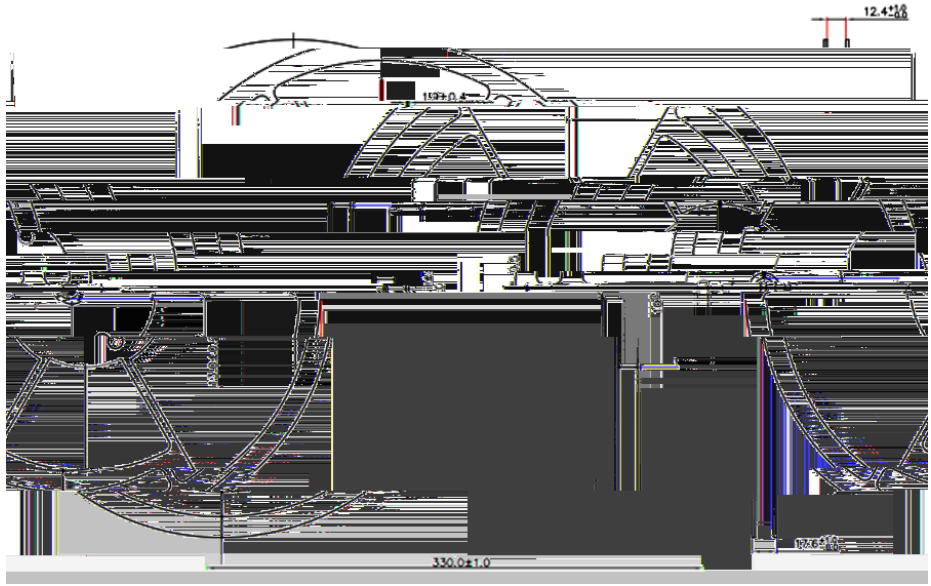

---

--	--	--	--

---

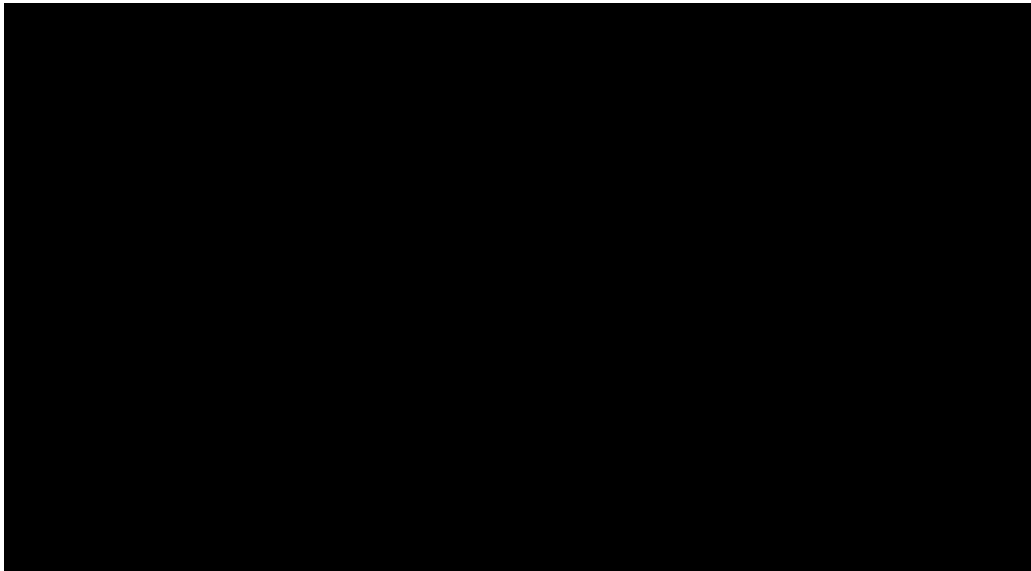
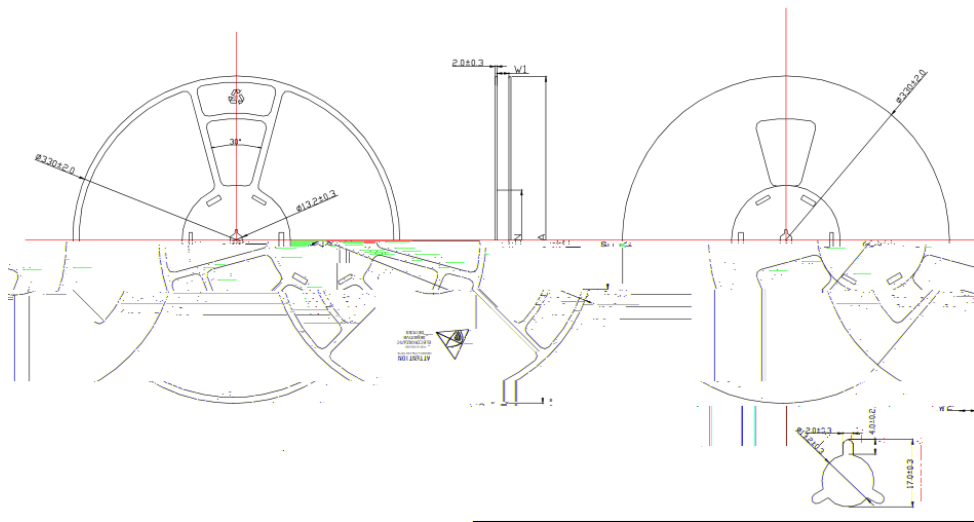

---

---

---