

4.5V-60V Vin, 3.5A, High Efficiency Step-down DCDC Converter with Programmable Frequency

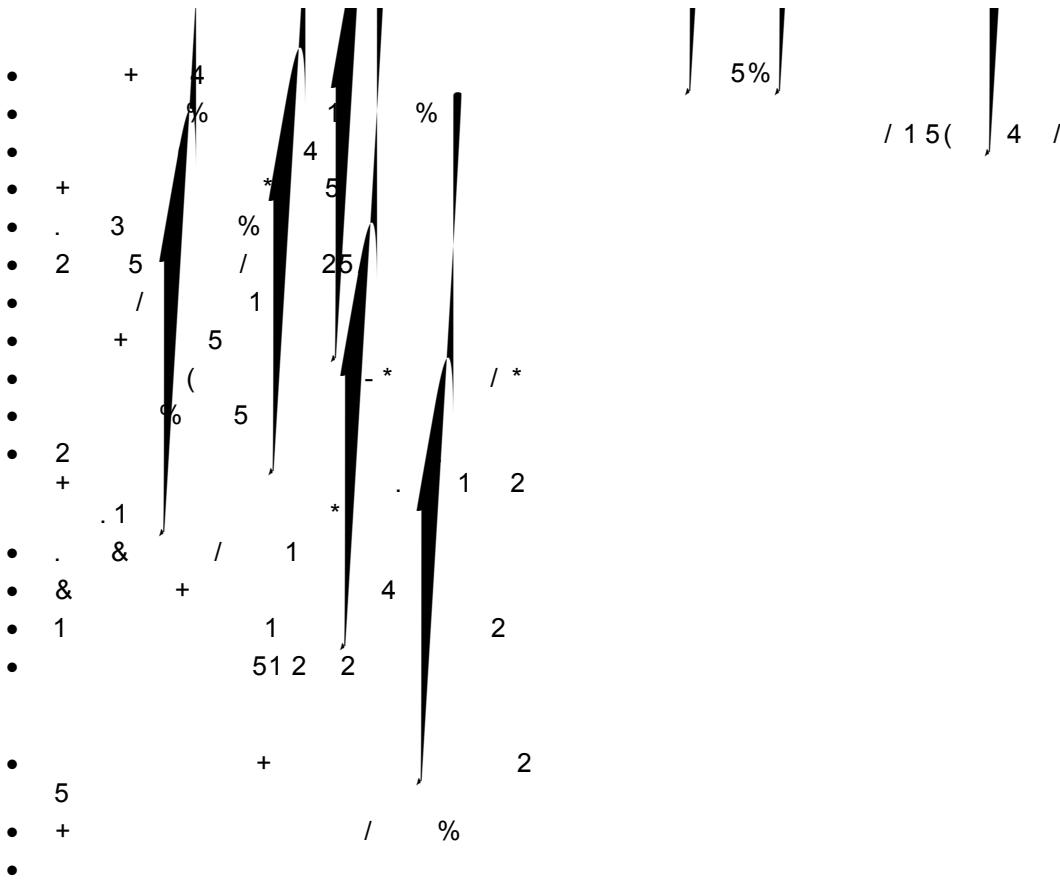

01 2
4 2

5%	5	1) (4	5	4	5%	5	4	512
----	---	------	---	---	---	----	---	---	-----

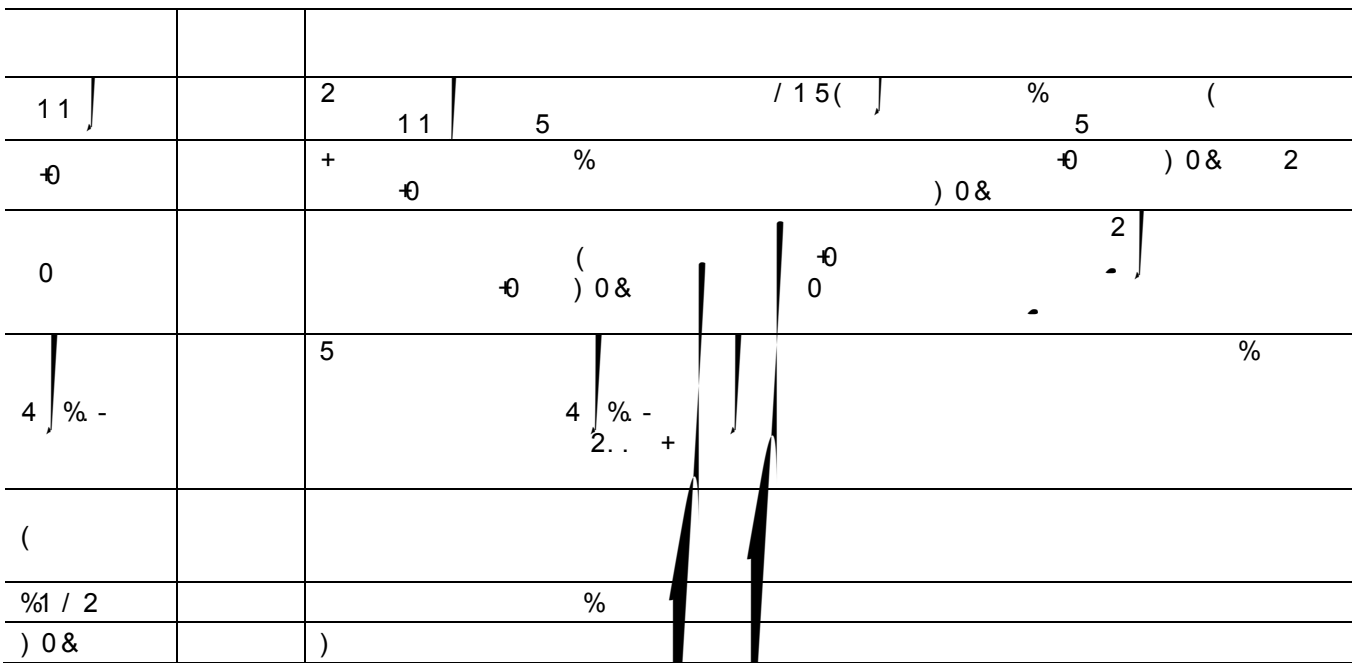
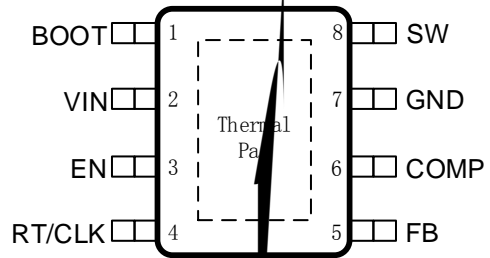
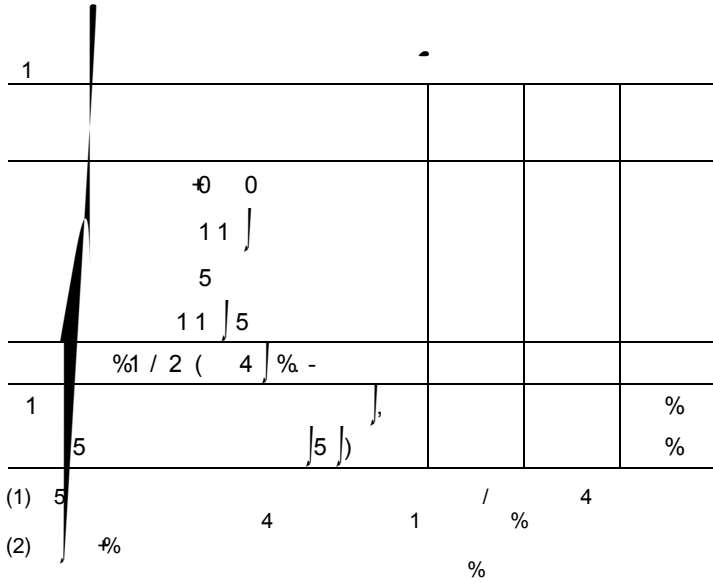

(2 (5 % 4 4

5		4	%	5
2		*	2%) 0& /

1

0	+			
1	1			
	1			%

5&		* / * / 05+, & %, 5		
	% & / %&/ 05+, & %, 5			
(1) , & %	, 2	* /		5&
(2) , & %	, 2	%&/		5&

	,			%
	,			

0	%	%	%	
---	---	---	---	--

0	1			
0 .1	+ .1	0		
t* & 0	5	0		
t	3	0	11	5

4&510 *	* / 15(11	5	
---------	---------	----	---	--

4 (4 (
)		1/2	1/2	5
1/2 54%		(4 (1/2	
1/2 50-		(4 (1/2	



%1 / 2 *	%1 / 2			
%1 / 2 .	%1 / 2			
+4 *5	* / 15(]			
0 *				
+0 .		0		
+0 *		0		
]55	5			
(4 0) 4]	(4]			*
(5	5	44]		*
10 / 0	/	0		
1 2	((4 (
11]	11] 5 .1	(4 (
]5&]]	11] 5		
		*		%
		*		%

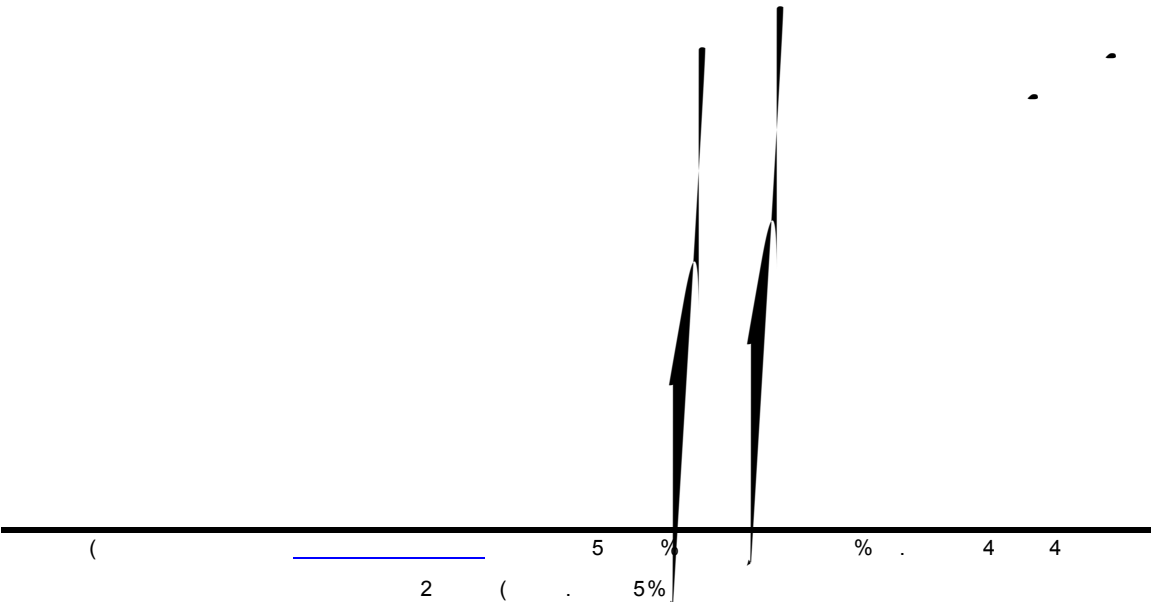



(. % (

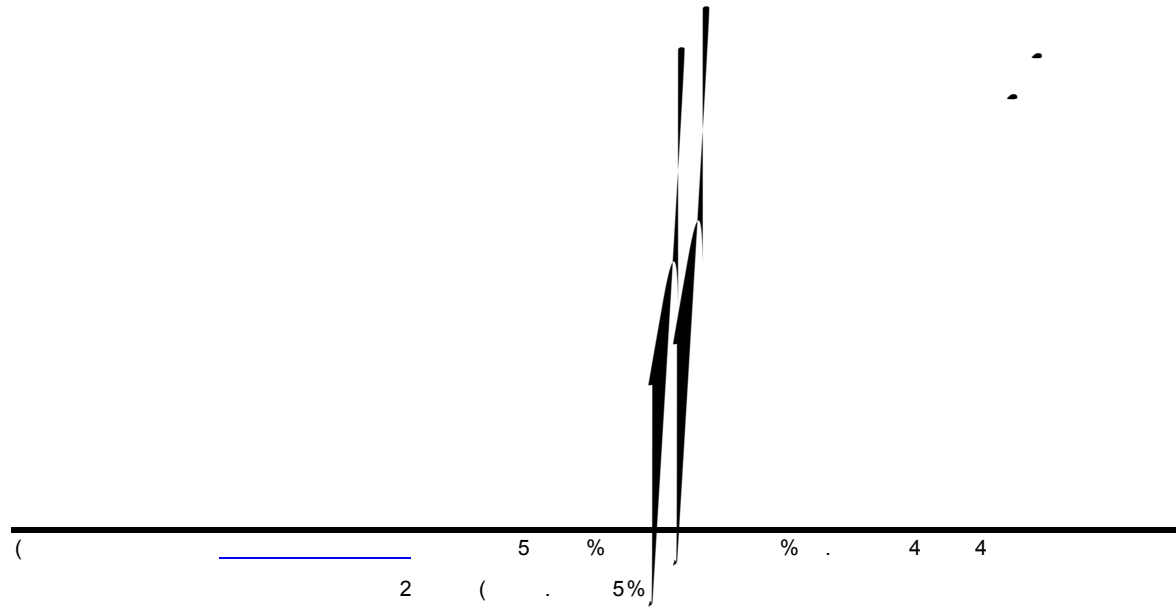

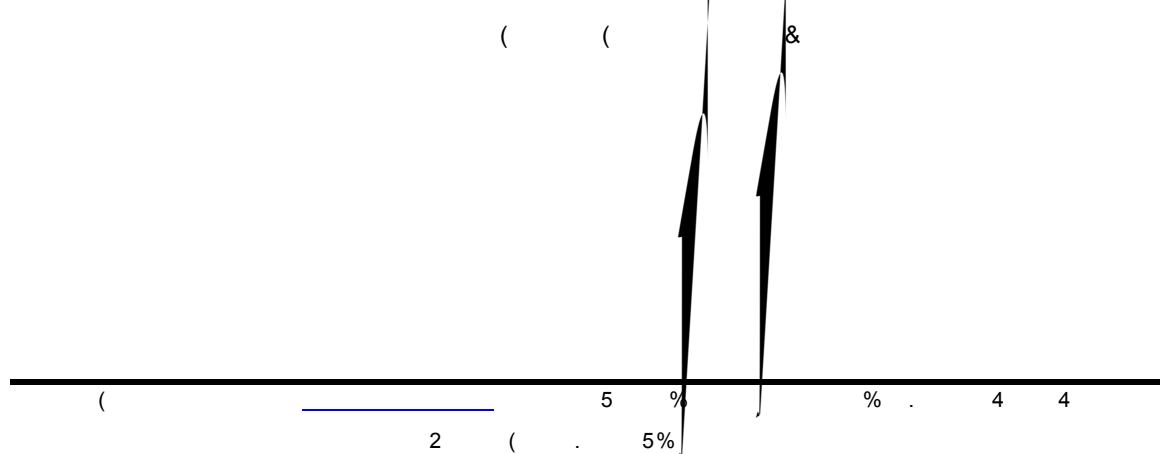
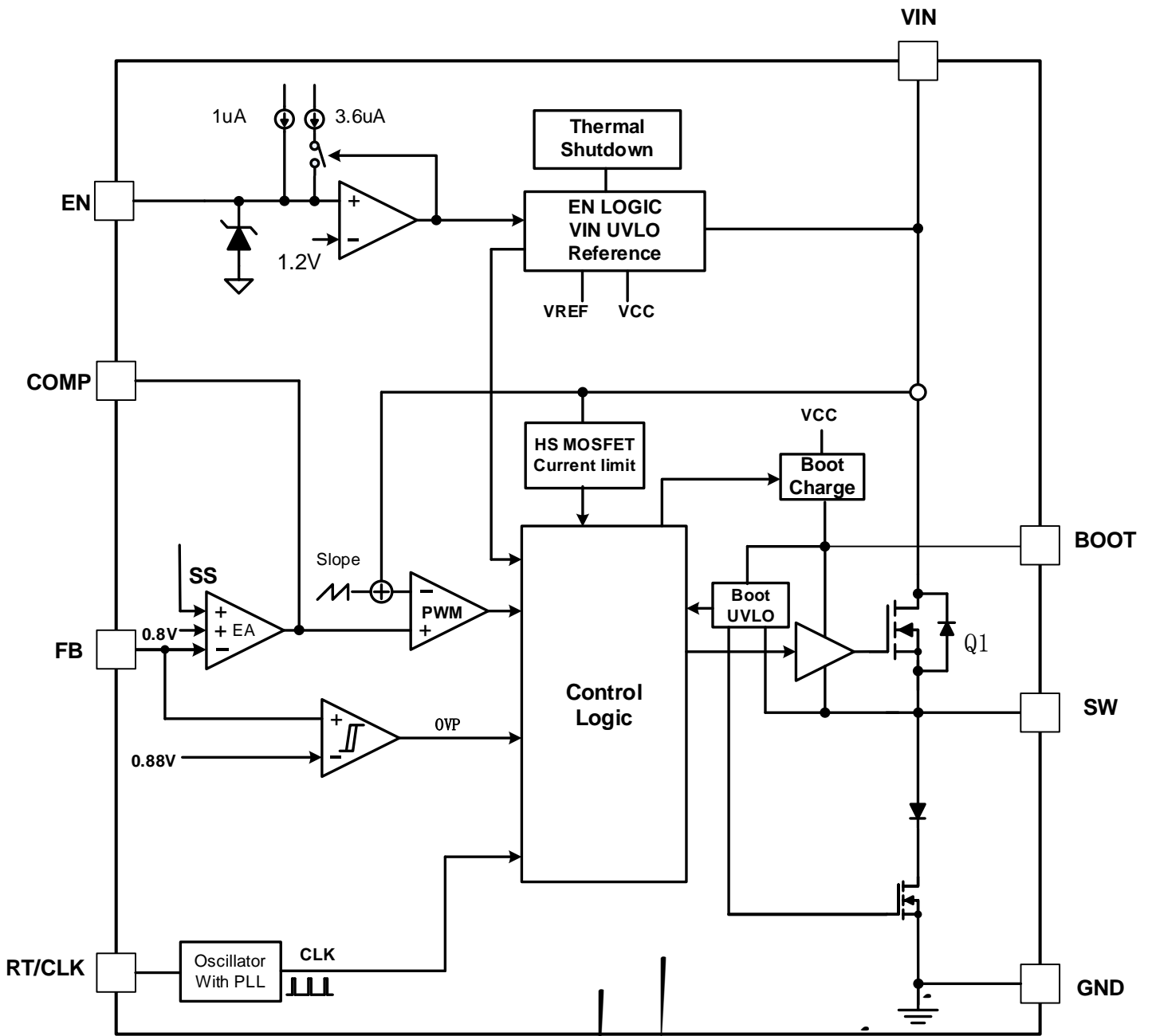

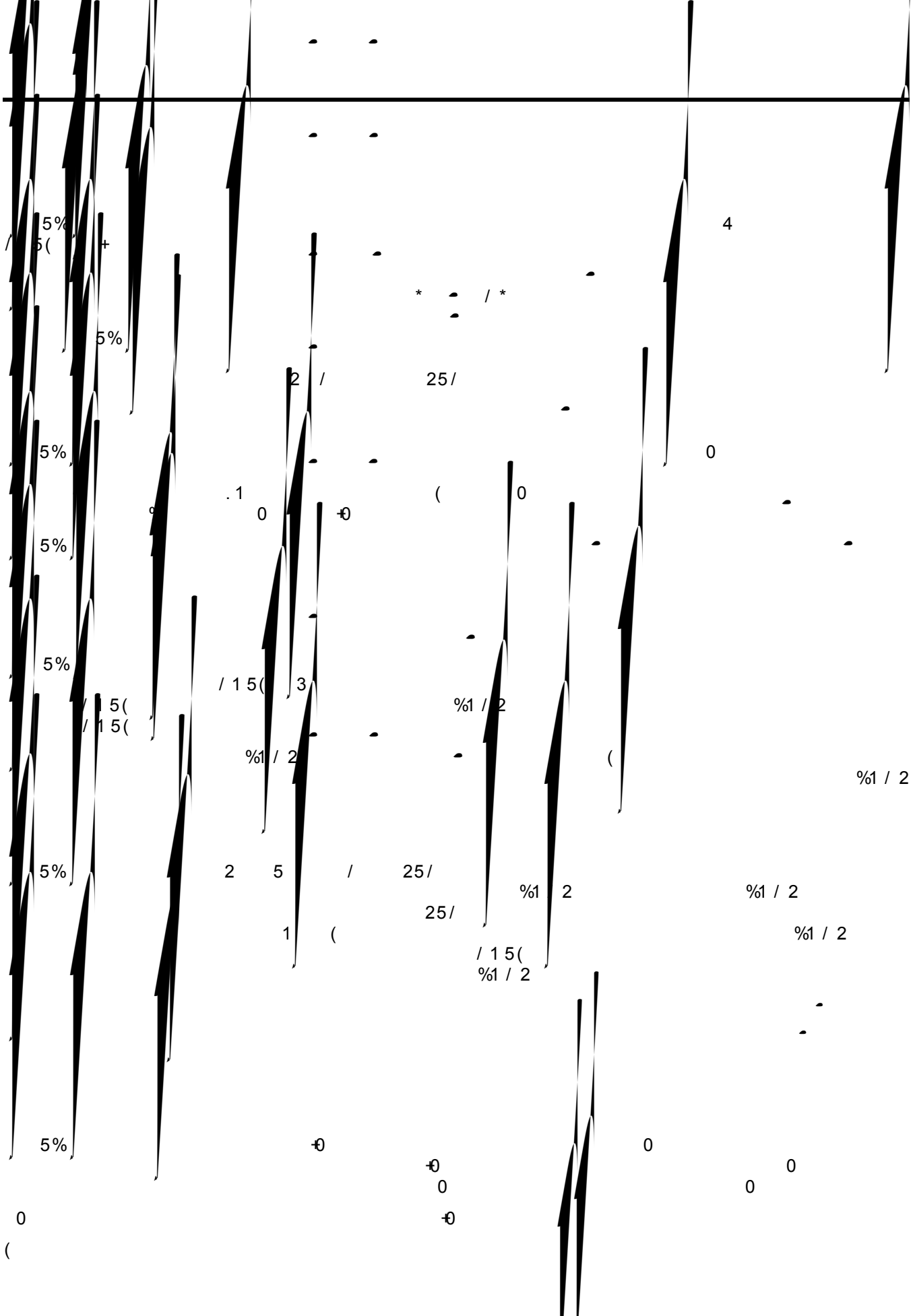

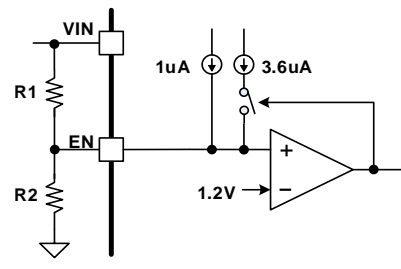

5%

±1% tolerance

4 (1.2)
4 (1)

5%

+ 0

5%

4 % -

(



2

(

5

5%

%

4

4

+

(

(

2

(

5

%

5%

%

4

4



..

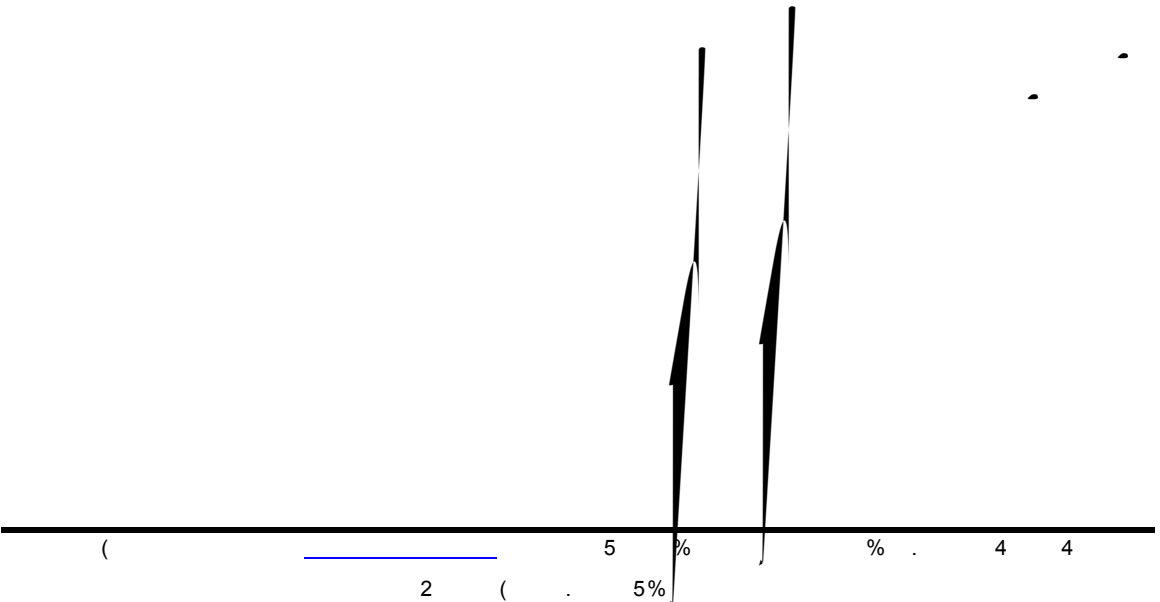
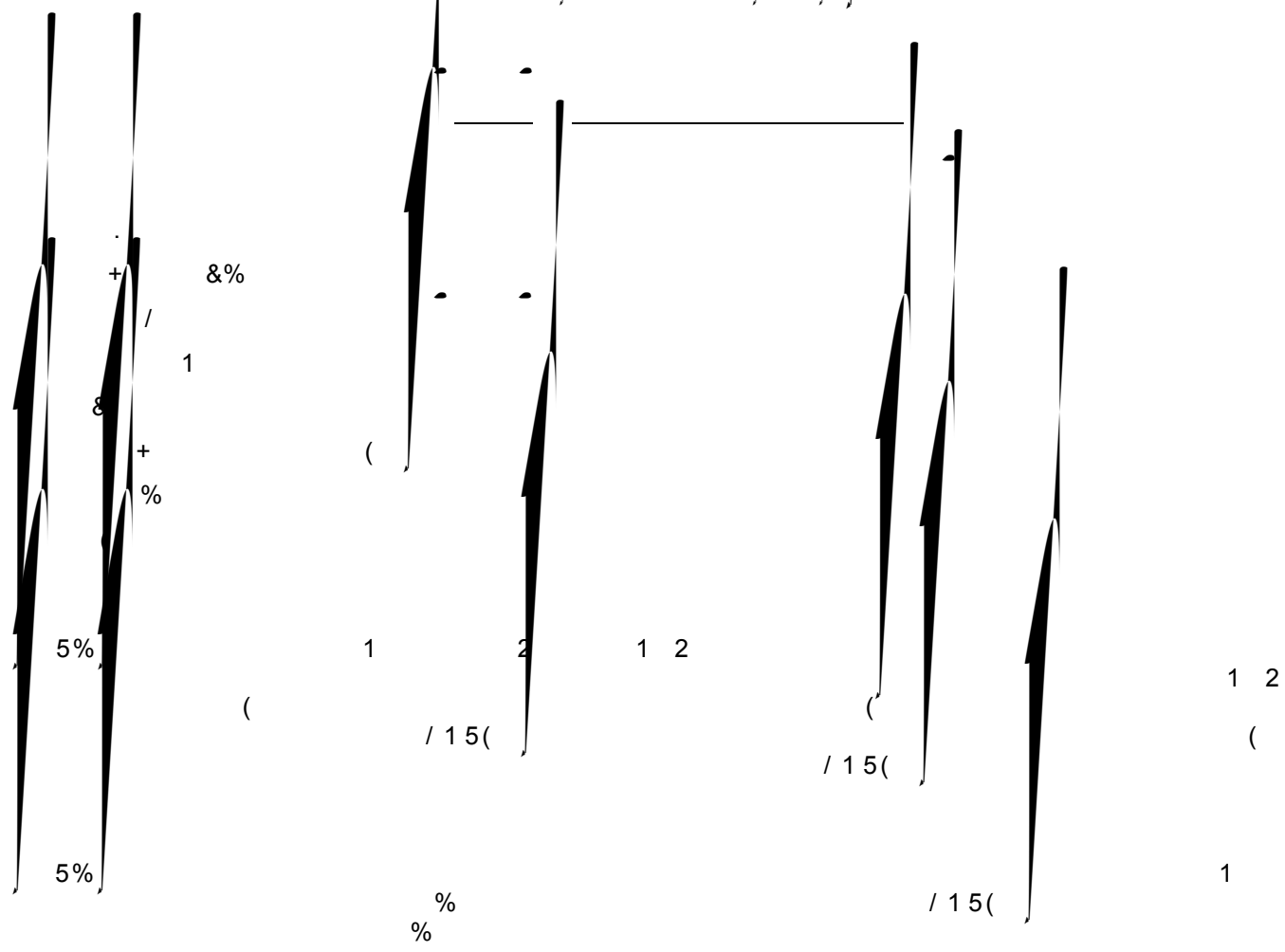

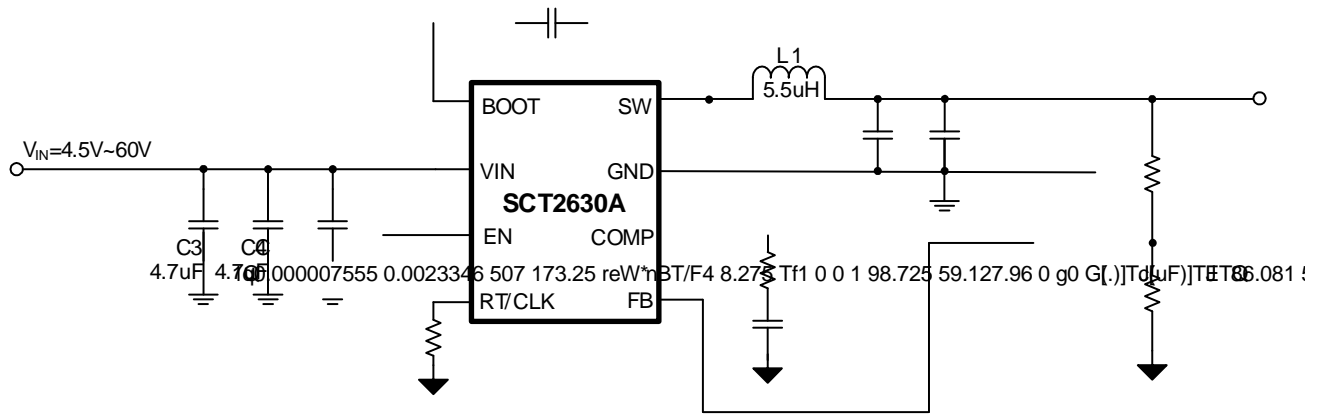

2

+			0
1			
/	1	%	
5	(- *
1			
	4		
5	+	0	
5	+	0	

4
4

4
4

-

	-	-
	-	-
	-	-
	-	-
	-	-
	-	-
	-	-
	-	-

• 4 (

*

*

+

*

]

4] % }) 0 &

(

	- *	-
	- *	-
	- *	-
	- *	-

• 5

. 1 4 .1

0 .1 4 0

(

4 4

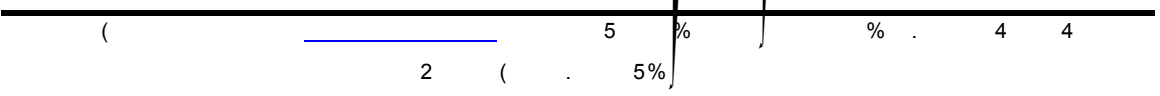

4/5

&%

&%4

+22

+22

5

1

0

5

1

0

+

4

+22

&%

+

4/5

+2

+4/5

+2

+

+22

+4/5

&%

4/5

+

5%

+2

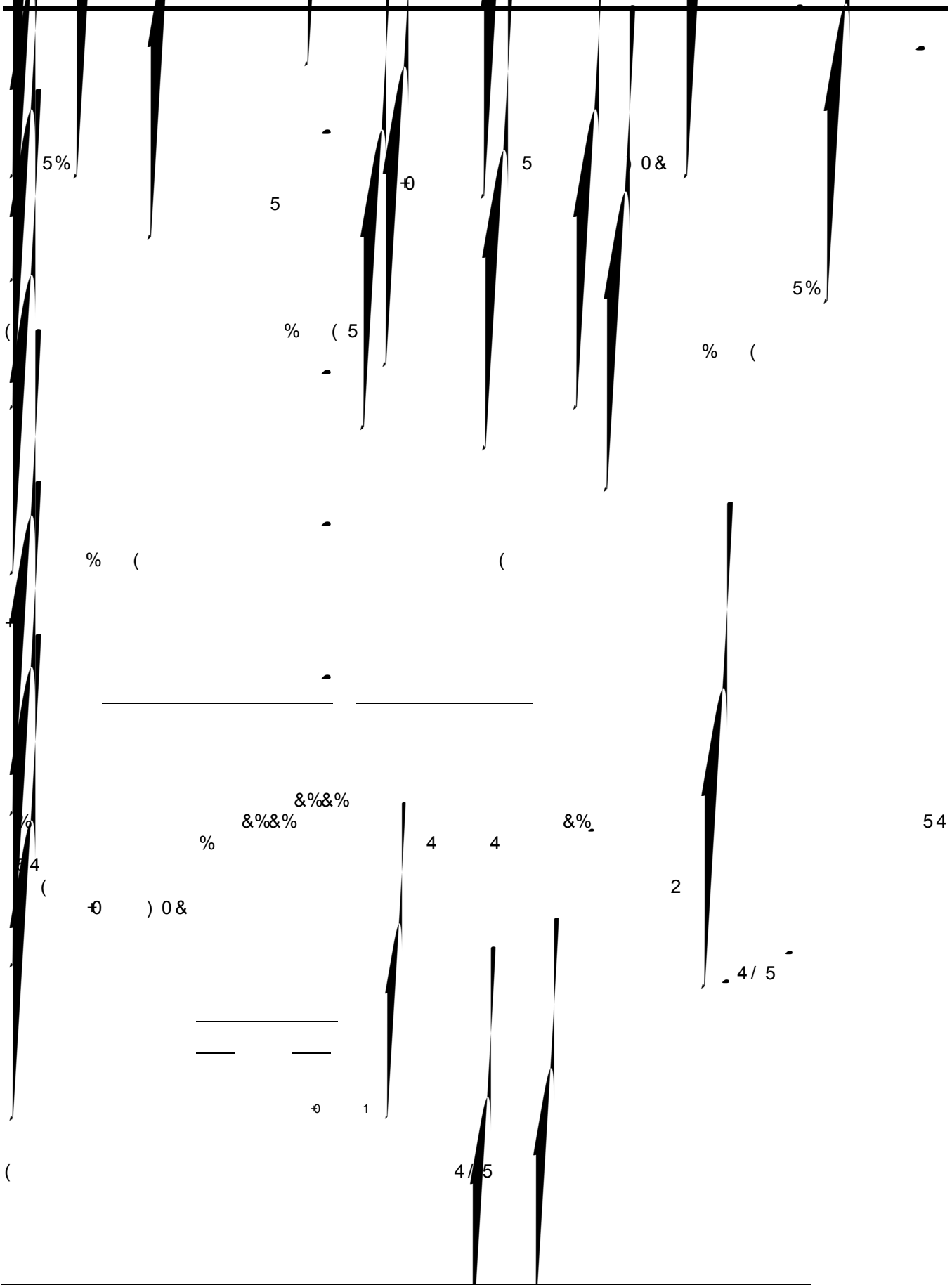

5%

5

+

5

0&

5%

% (5

% (

% (

(

54

&%&%

%

4

4

&%

2

4/5

⊖) 0&

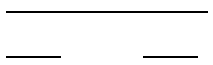

⊖ 1

4/5

(. 5 % . % . 4 4

2 (5%

&%

(

(

(

2

(

5

%

5%



%

4

4

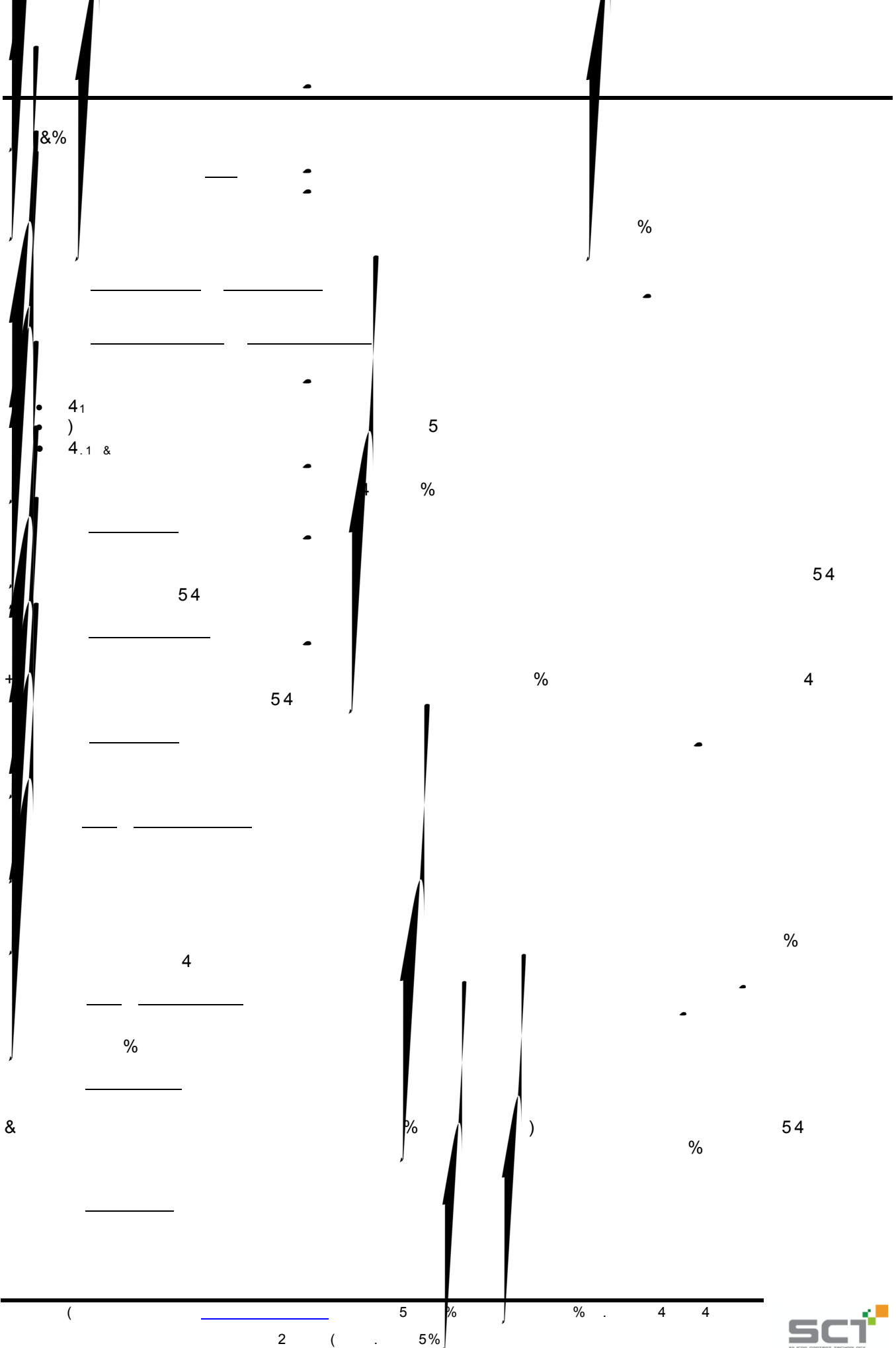

&%

41

4.1 &

5

%

54

54

54

%

4

4

%

%

&

%

)

%

54

(

2

(

5

5%

%

4

4

5%

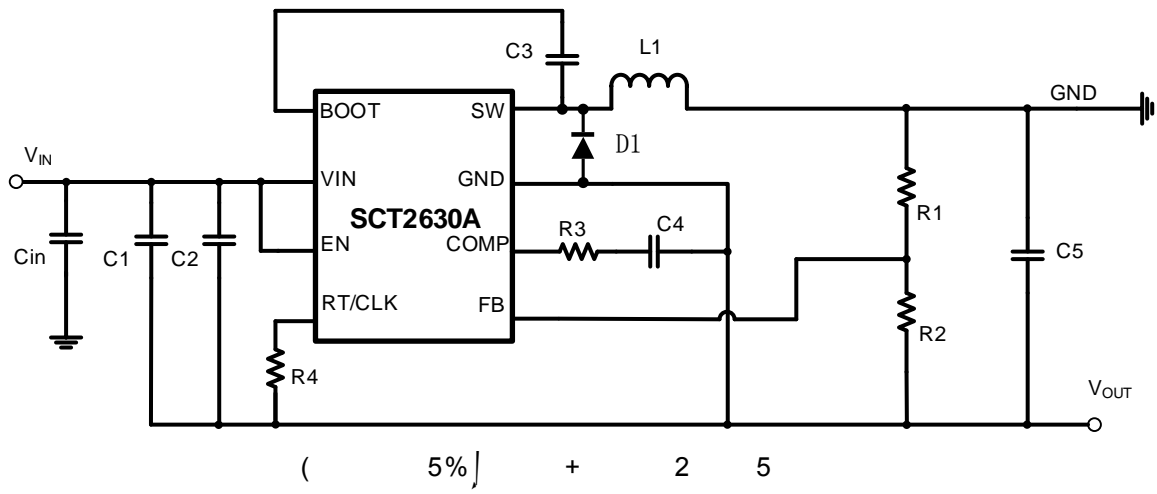

(5%] + 2 5

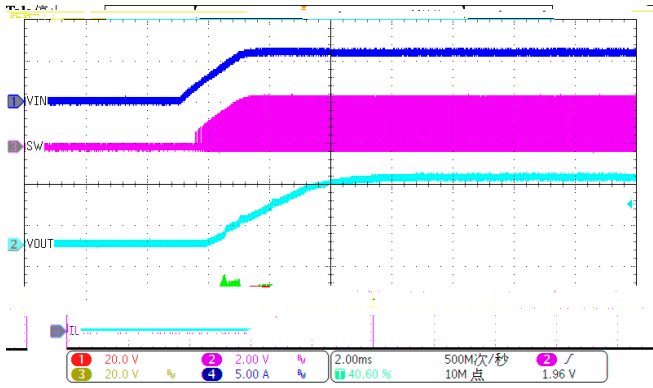

(2 +

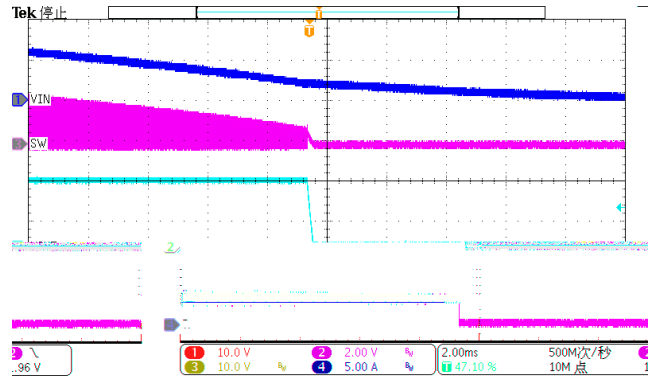

(2 +

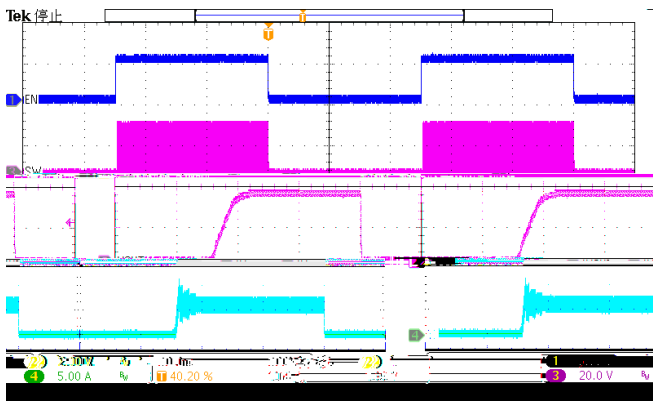

(0 +

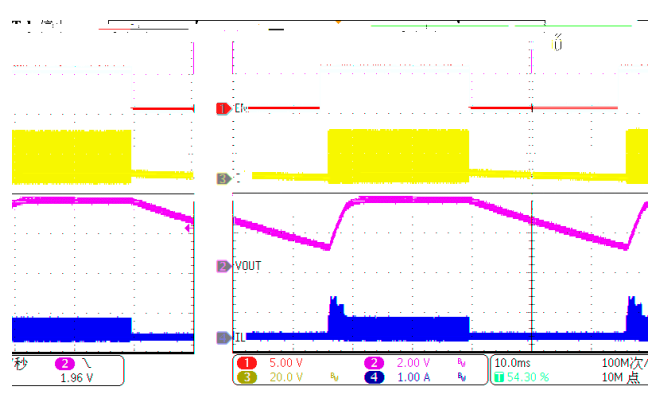

(0 +

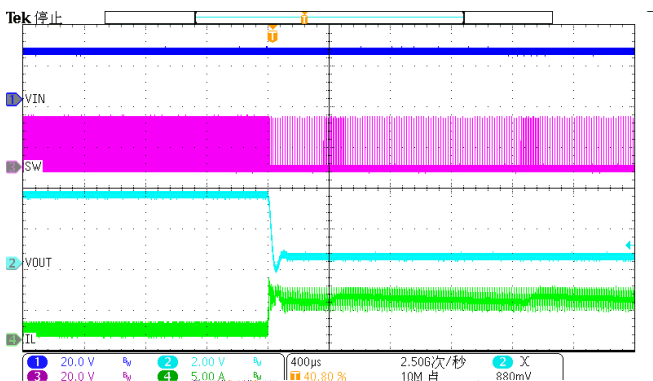

(1 % 2

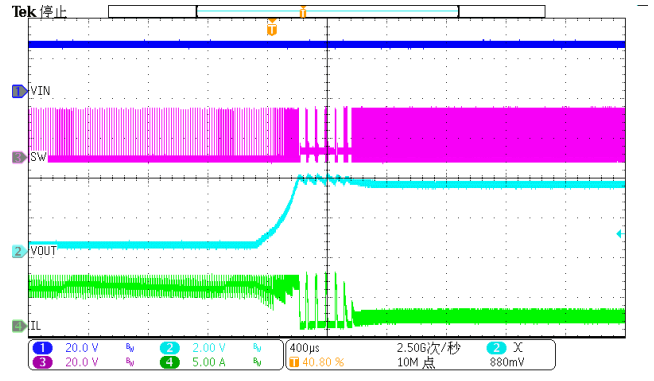

(% 4

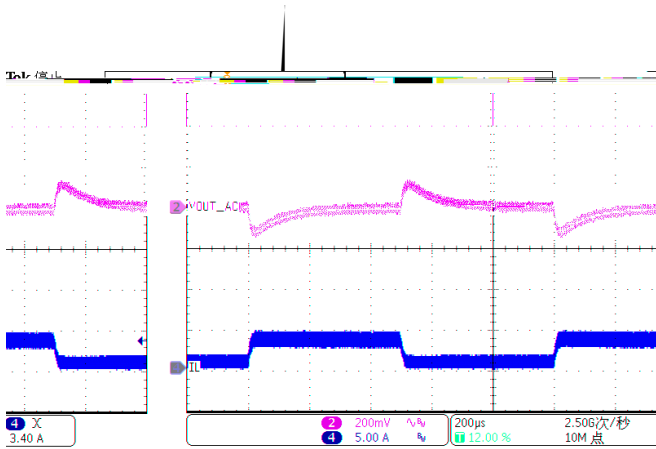

(.)

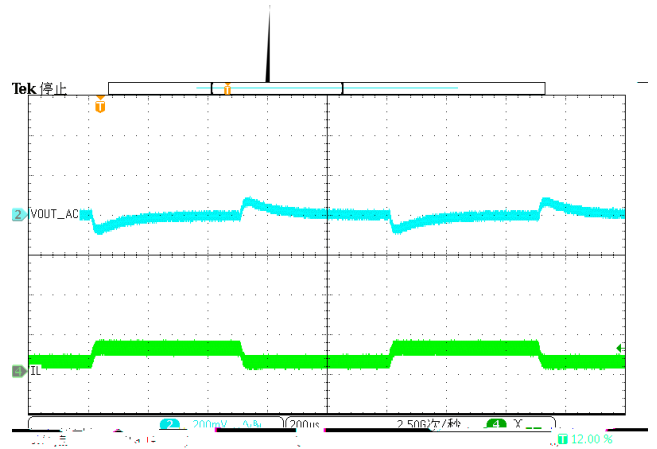

(.)

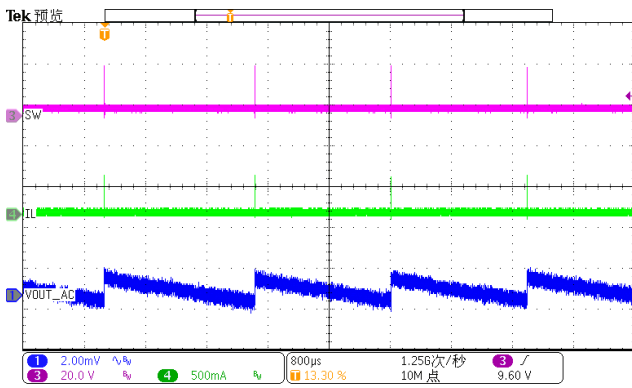

(1 4 +)

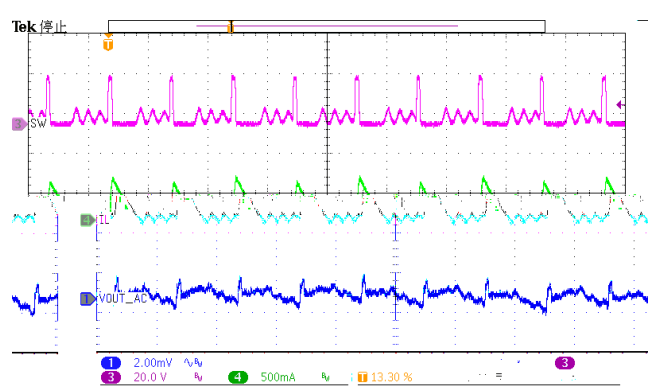

(1 4 +)

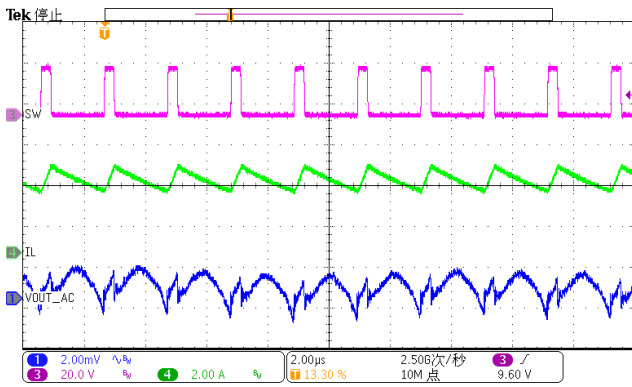

(1 4 +)

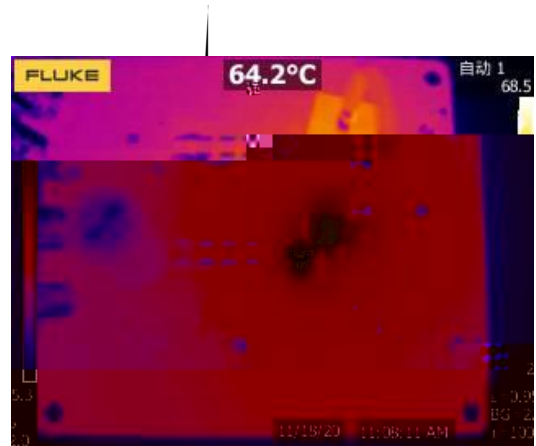

(.) 0

(.) 5 %

2 (.) 5 %

4 4

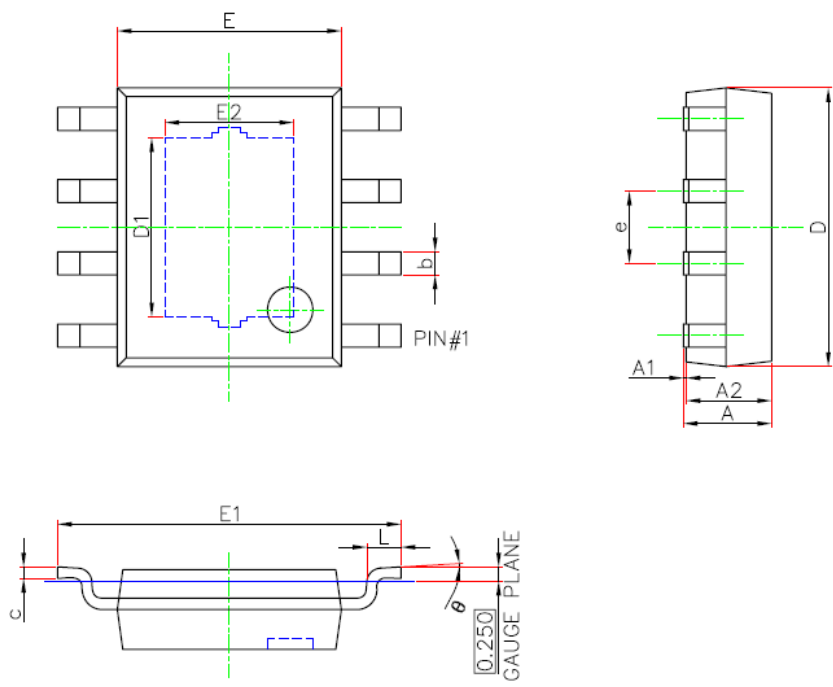

5 1 2 2 2 1 &

5	&	/	/	/	&	+
	/		/		/	/
&						
&						
			5%			5%
.						.
θ						.

1. &
2. &
3. &
4. &
5. &
6. % 2%

/ 1

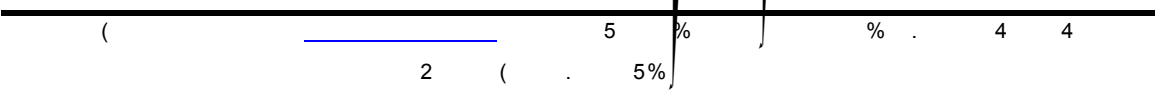

1	&	2	2	523
5%	5	4	51 2	

